

INSTALLATION MANUAL

MODEL 3325B SYNTHESIZER/FUNCTION GENERATOR

Serial Number: ALL

IMPORTANT NOTICE

This manual applies to all instruments. Documentation changes required after the printing of this manual are shown on a manual change supplement which accompanies this manual.

WARNING

*To prevent potential fire or shock hazard,
do not expose instrument to rain or moisture.*

Manual Part No. 03325-90006
Microfiche Part No. 03325-90206

©Copyright Hewlett-Packard Company 1978, 1981, 1984, 1988
8600 Soper Hill Road
Everett, Washington 98205-1298 U.S.A.

Printed: January 1988

CERTIFICATION

Hewlett-Packard Company certifies that this product met its published specifications at the time of shipment from the factory. Hewlett-Packard further certifies that its calibration measurements are traceable to the United States National Bureau of Standards, to the extent allowed by the Bureau's calibration facility, and the calibration facilities of other International Standards Organization Members.

WARRANTY

This Hewlett-Packard product is warranted against defects in material and workmanship for a period of one year from date of shipment. During the warranty period, Hewlett-Packard Company will, at its option, either repair or replace products which prove to be defective.

For warranty service or repair, this product must be returned to a service facility designated by -hp-. Buyer shall prepay shipping charges to -hp- and -hp- shall pay shipping charges to return the product to Buyer. However, Buyer shall pay all shipping charges, duties, and taxes for products returned to -hp- from another country.

HP software and firmware products which are designated by HP for use with a hardware product, when properly installed on the hardware product, are warranted not to fail to execute their programming instructions due to defects in materials and workmanship. If HP receives notice of such defects during their warranty period, HP shall repair or replace software media and firmware which do not execute their programming instructions due to such defects. HP does not warrant that the operation of the software, firmware or hardware shall be uninterrupted or error free.

LIMITATION OF WARRANTY

The foregoing warranty shall not apply to defects resulting from improper or inadequate maintenance by Buyer, Buyer-supplied software or interfacing, unauthorized modification or misuse, operation outside of the environmental specifications for the product, or improper site preparation or maintenance.

NO OTHER WARRANTY IS EXPRESSED OR IMPLIED. HEWLETT-PACKARD SPECIFICALLY DISCLAIMS THE IMPLIED WARRANTIES OF MERCHANTABILITY AND FITNESS FOR PARTICULAR PURPOSE.

EXCLUSIVE REMEDIES

THE REMEDIES PROVIDED HEREIN ARE BUYER'S SOLE AND EXCLUSIVE REMEDIES. HEWLETT-PACKARD SHALL NOT BE LIABLE FOR ANY DIRECT, INDIRECT, SPECIAL, INCIDENTAL, OR CONSEQUENTIAL DAMAGES, WHETHER BASED ON CONTRACT, TORT, OR ANY OTHER LEGAL THEORY.

ASSISTANCE

Product maintenance agreements and other customer assistance agreements are available for Hewlett-Packard products.

For any assistance, contact your nearest Hewlett-Packard Sales and Service Office. Addresses are provided at the back of this manual.

SAFETY SUMMARY

The following general safety precautions must be observed during all phases of operation, service, and repair of this instrument. Failure to comply with these precautions or with specific warnings elsewhere in this manual violates safety standards of design, manufacture, and intended use of the instrument. Hewlett-Packard Company assumes no liability for the customer's failure to comply with these requirements. This is a Safety Class 1 instrument.

GROUND THE INSTRUMENT

To minimize shock hazard, the instrument chassis and cabinet must be connected to an electrical ground. The instrument is equipped with a three-conductor ac power cable. The power cable must either be plugged into an approved three-contact electrical outlet or used with a three-contact to two-contact adapter with the grounding wire (green) firmly connected to an electrical ground (safety ground) at the power outlet. The power jack and mating plug of the power cable meet International Electrotechnical Commission (IEC) safety standards.

DO NOT OPERATE IN AN EXPLOSIVE ATMOSPHERE

Do not operate the instrument in the presence of flammable gases or fumes. Operation of any electrical instrument in such an environment constitutes a definite safety hazard.

KEEP AWAY FROM LIVE CIRCUITS

Operating personnel must not remove instrument covers. Component replacement and internal adjustments must be made by qualified maintenance personnel. Do not replace components with power cable connected. Under certain conditions, dangerous voltages may exist even with the power cable removed. To avoid injuries, always disconnect power and discharge circuits before touching them.

DO NOT SERVICE OR ADJUST ALONE

Do not attempt internal service or adjustment unless another person, capable of rendering first aid and resuscitation, is present.

DO NOT SUBSTITUTE PARTS OR MODIFY INSTRUMENT

Because of the danger of introducing additional hazards, do not install substitute parts or perform any unauthorized modification to the instrument. Return the instrument to a Hewlett-Packard Sales and Service Office for service and repair to ensure the safety features are maintained.

DANGEROUS PROCEDURE WARNINGS

Warnings, such as the example below, precede potentially dangerous procedures throughout this manual. Instructions contained in the warnings must be followed.

WARNING

Dangerous voltages, capable of causing death, are present in this instrument. Use extreme caution when handling, testing, and adjusting.

SAFETY SYMBOLS

General Definitions of Safety Symbols Used On Equipment or In Manuals.



Instruction manual symbol: the product will be marked with this symbol when it is necessary for the user to refer to the instruction manual in order to protect against damage to the instrument.



Indicates dangerous voltage (terminals fed from the interior by voltage exceeding 1000 volts must be so marked.)

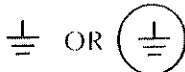

Protective conductor terminal. For protection against electrical shock in case of a fault. Used with field wiring terminals to indicate the terminal which must be connected to ground before operating equipment.



Low-noise or noiseless, clean ground (earth) terminal. Used for a signal common, as well as providing protection against electrical shock in case of a fault. A terminal marked with this symbol must be connected to ground in the manner described in the installation (operating) manual, and before operating the equipment.

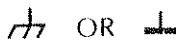

Frame or chassis terminal. A connection to the frame (chassis) of the equipment which normally includes all exposed metal structures.



Alternating current (power line.)



Direct (power line.)



Alternating or direct current (power line.)

WARNING *The WARNING sign denotes a hazard. It calls attention to a procedure, practice, condition or the like, which if not correctly performed or adhered to, could result in injury or death to personnel.*

CAUTION *The CAUTION sign denotes a hazard. It calls attention to an operating procedure, practice, condition or the like, which, if not correctly performed or adhered to, could result in damage to or destruction of part or all of the product.*

NOTE *The NOTE sign denotes important information. It calls attention to procedure, practice, condition or the like, which is essential to highlight.*

Table of Contents

HP 3325B Installation	4-1	Close-In Spurious Signal	4-19
General Installation Information	4-2	Performance Tests	4-20
Initial Inspection	4-2	Required Test Equipment	4-20
Power Requirements	4-2	Harmonic Distortion	4-23
Line Voltage Selection	4-3	Spurious Signal	4-25
Over-Voltage Protect Circuit Breaker	4-3	Integrated Phase Noise	4-27
Power Cable and Grounding Requirements	4-4	Amplitude Modulation Envelope Distortion	4-28
Operating Environment	4-6	Square Wave Rise Time and Aberrations	4-29
Temperature	4-6	Ramp Retrace Time	4-30
Humidity	4-6	Sync Output	4-30
Altitude	4-6	Square Wave Symmetry	4-31
Instrument Cooling	4-6	Frequency Accuracy	4-32
Installation	4-6	Phase Increment Accuracy	4-33
HP-IB System Interface Connections	4-8	Phase Modulation Linearity	4-34
Storage And Shipment	4-10	Amplitude Accuracy	4-38
Operational Verification	4-11	DC Offset Accuracy (DC Only)	4-45
Required Test Equipment	4-11	DC Offset Accuracy with AC Functions ..	4-46
Self Test	4-12	Triangle Linearity	4-47
Sine Wave Verification	4-12	X Drive Linearity	4-50
Square Wave Verification	4-13	Ramp Period Variation	4-54
Triangle and Ramp Verification	4-14		
Amplitude Flatness Check	4-15	Operational Verification Record	
Sync Output Check	4-15	Performance Test Record	
Frequency Accuracy	4-16	Specifications (Appendix A)	
Output Level and Attenuator Check	4-16	Index	
Harmonic Distortion	4-17		

HP 3325B Installation

This section contains instructions for installing and interfacing the HP 3325B Synthesizer/Function Generator as well as tests to verify performance. Included are initial inspection procedures, power and grounding requirements, operating environment, available accessories and options, installation instructions, interfacing procedures, and instructions for repacking and shipping.

There are two sets of tests: the first, operational verification, is a subset of the second, performance tests, an exhaustive test of the HP 3325B specifications. The operational verification is typically used as an incoming inspection tool upon initial receipt. The performance tests are used just before shipping from the factory, after any service work, and when a full calibration is performed.

General Installation Information

Initial Inspection

The HP 3325B was carefully inspected both mechanically and electrically before shipment. It should be free of marks or scratches and in perfect electrical order upon receipt. To assure that this is the case, perform the following steps:

- Inspect the HP 3325B for physical damage incurred in transit. If the HP 3325B was damaged in transit, file a claim with the carrier.

Warning *The integrity of the protective earth ground may be interrupted if the HP 3325B is mechanically damaged. Under no circumstances should the HP 3325B be connected to power if it is damaged.*

- Check for supplied accessories (listed in Chapter 3 of the Operating Manual).

Inspection will be completed after testing the electrical performance using the Operational Verification tests which appear later in this document. Also included in this document is the Performance Test. This is a very detailed test procedure designed to verify that the HP 3325B meets all the performance specifications.

Power Requirements

Caution *Before applying ac line power to the HP 3325B, ensure the voltage selector on the HP 3325B rear panel is set for the proper line voltage and the correct line fuse is installed in the fuse holder. Procedures for changing the line voltage selector and fuse are contained in the following section for "Line Voltage Selection."*

The HP 3325B can operate from any single phase ac power source supplying 100V, 120V, 220V or 240V in the frequency range from 47 to 66 Hz (see table 4-1). With all options installed, power consumption is less than 100 VA.

Table 4-1. Line Voltage Ranges

Selector Voltage	AC Voltage Range
100	90-108V
120	108-126V
220	198-231V
240	216-252V

Line Voltage Selection

The line voltage selector is set at the factory to correspond to the most commonly used line voltage of the country of destination. The line voltage selected for the HP 3325B is indicated on the line voltage selector (refer to figure 4-1). Refer to table 4-1 for the line voltage ranges and table 4-2 to set the line voltage and select the appropriate fuse. To change the line voltage and fuse:

1. Remove the power cord.
2. Pry open the power selector cover on the rear panel with a small screwdriver (see figure 4-1).
3. To check or replace the fuse, pull the white fuse holder out of the power selector and remove the fuse from the fuse holder.
4. To reinstall the fuse, insert a fuse with the proper rating into the fuse holder. The white arrow on the fuse holder handle should point toward the top of the instrument. Push the fuse holder into the power selector.
5. To change the line voltage, remove the cylindrical line voltage selector.

Caution *Remove line voltage selector to change voltage. Rotating the selector without removing the cylinder could damage the module.*

6. Reinstall the cylindrical line voltage selector and ensure the required voltage label is facing out of the power selector. The cylinder is keyed so that it can not be installed backwards.
7. Close the power selector by pushing the side catches in (toward the center of the cover) and then pressing down firmly on the cover.
8. Check that the correct line voltage appears through the window in the power selector cover.

Table 4-2. Line Voltage and Fuse Selection

Line Setting	Fuse Type	HP Part Number
100V/120V	1A 250V Quick-Acting (F)	2110-0732
220V/240V	500 mA 250V Quick-Acting (F)	2110-0733

Over-Voltage Protect Circuit Breaker

In addition to the current protection provided by the line fuse, the HP 3325B is protected by an over-voltage circuit breaker. This device disconnects the power supply from the main power connector when the line voltage exceeds the upper limit. The reset switch, located on the rear panel (figure 4-1), pops out when this occurs. If this occurs:

1. Turn the power switch to STANDBY (Ⓞ) and disconnect the power cord.
2. Check the setting of the line-voltage selector, as described earlier in this chapter, to be sure that it matches the power connected to the HP 3325B.

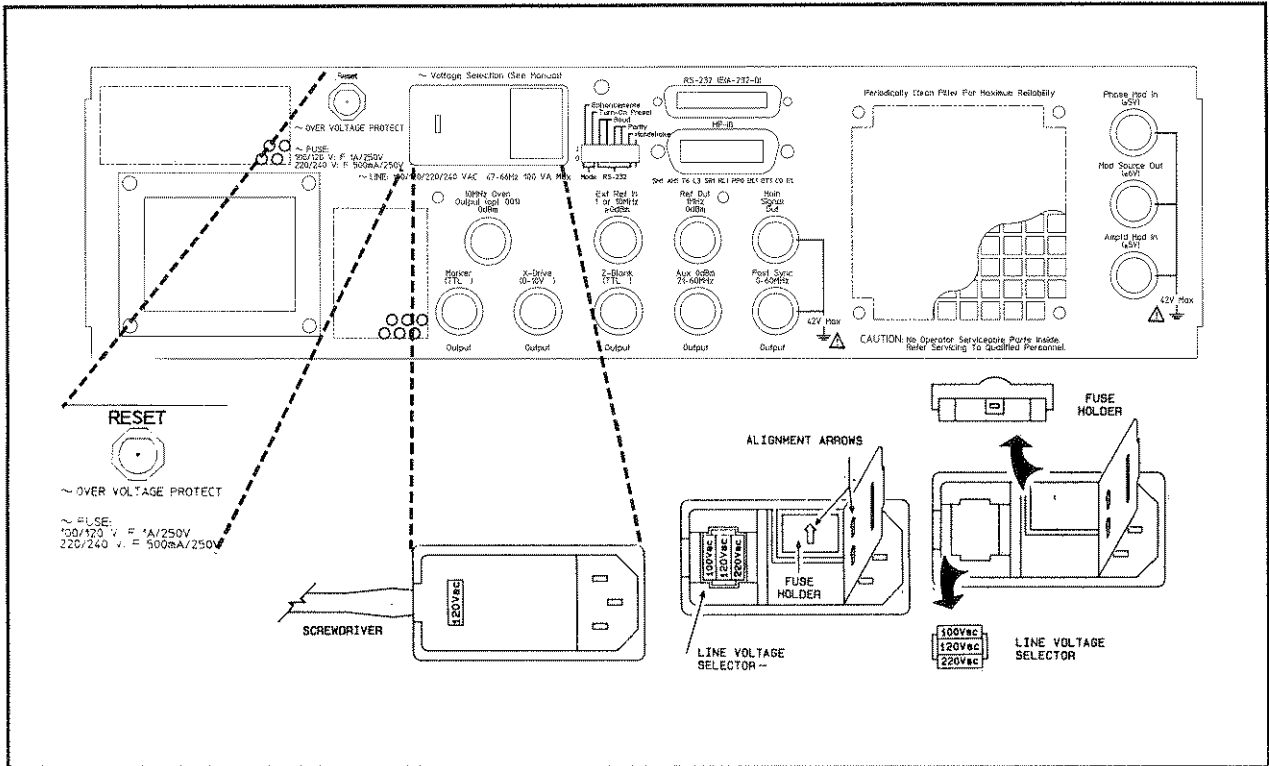

Figure 4-1. Line Voltage Selection, Fuse Replacement, and Circuit Breaker

3. Reset the circuit breaker by pushing the reset switch on the rear panel.
4. Reconnect the power cord and turn the power switch on.

If the circuit breaker pops out when power is restored and the line voltage level is within the limits described in table 4-1, send the HP 3325B to a qualified service facility for repair.

Warning *Line voltages should be measured by a qualified service person who is aware of the hazards involved.*

If the circuit breaker does not open and the HP 3325B does not operate, remove power and check line fuse.

Power Cable and Grounding Requirements

The HP 3325B is equipped with a three-conductor power cord which, when plugged into an appropriate receptacle, grounds the HP 3325B cabinet. The type of power cable plug shipped with each instrument depends on the country of destination. Refer to figure 4-2 for the part number of the power cable and plug configurations available.

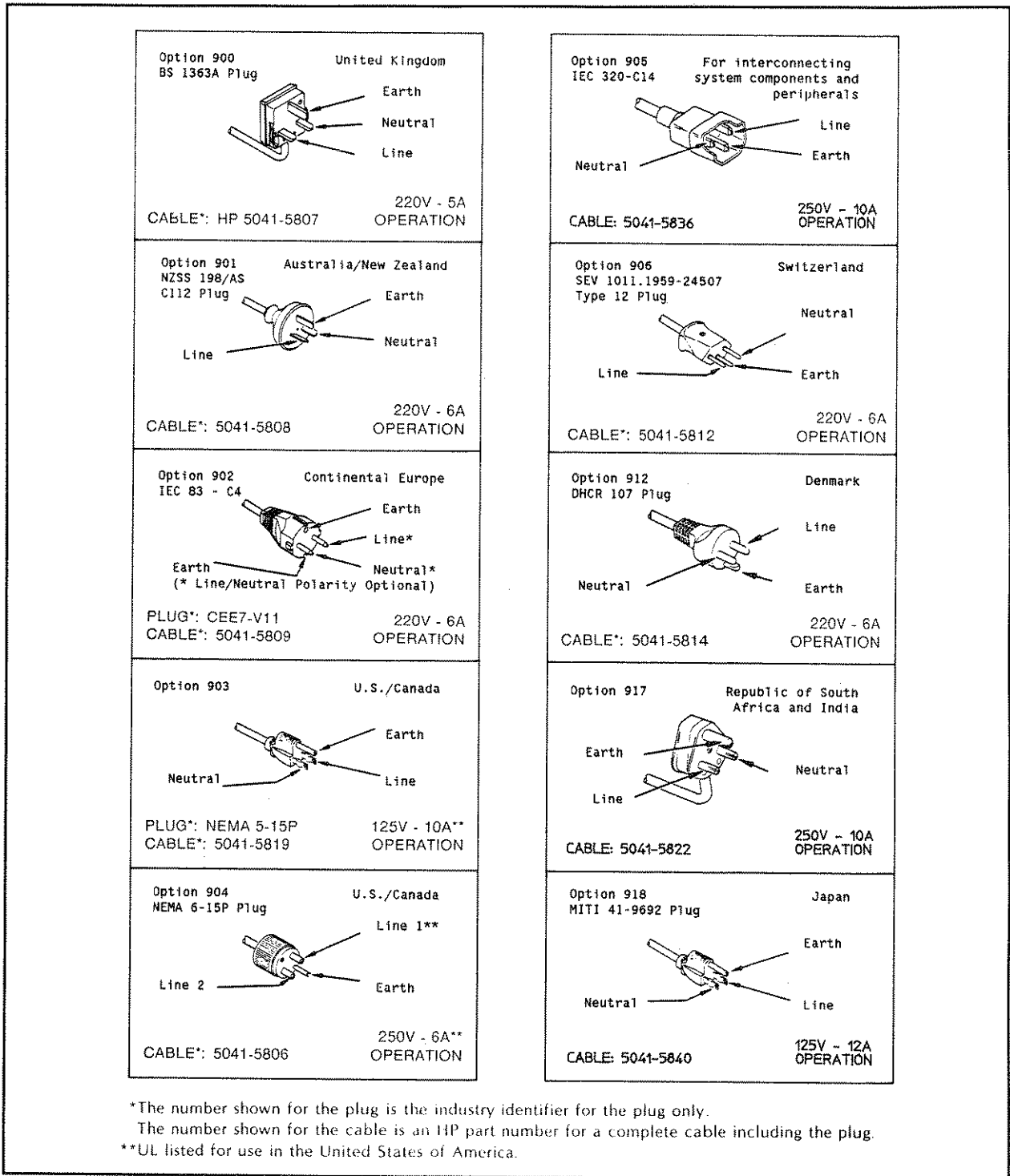

Figure 4-2. Power Cables

WARNING The power cable plug must be inserted into a socket outlet provided with a protective earth terminal. Defeating the protection of the grounded instrument cabinet can subject the operator to lethal voltages.

Operating Environment

The following summarizes the HP 3325B operating environment ranges. In order for the HP 3325B to meet specifications, the operating environment must be within these limits.

Warning *The HP 3325B is not designed for outdoor use. To prevent potential fire or shock hazard, do not expose the HP 3325B to rain or other excessive moisture.*

Temperature

The HP 3325B may be operated in temperatures from 0°C to 55°C.

Humidity

The HP 3325B may be operated in environments with humidity up to 95% (0°C to +40°C). However, the HP 3325B should be protected from temperatures or temperature changes which cause condensation within the instrument.

Altitude

The HP 3325B may be operated at altitudes up to 4572 meters (15,000 feet).

Instrument Cooling

The HP 3325B is equipped with a cooling fan mounted on the rear panel. The HP 3325B should be mounted so that air can freely circulate through it. When operating the HP 3325B, choose a location that provides at least 75 mm (3 inches) of clearance at the rear, and at least 25 mm (1 inch) of clearance at each side. Failure to provide adequate air clearance will result in excessive internal temperature, reducing instrument reliability. The filter for the cooling fan can be cleaned without removing it. The filter (HP part number 3150-0387) should be cleaned with a vacuum cleaner every thirty days.

Installation

The HP 3325B is shipped with plastic feet in place, ready for use as a portable bench instrument. The plastic feet are shaped to make full width modular instruments self-align when they are stacked. The clearances provided by the plastic feet in bench stacking and the filler strip in rack mounting allow air passage across the top and bottom cabinet surfaces.

A front handle kit can be installed for ease of handling the HP 3325B on the bench. The part number for the front handle kit is listed in table 3-3 of the *HP 3325B Operating Manual*.

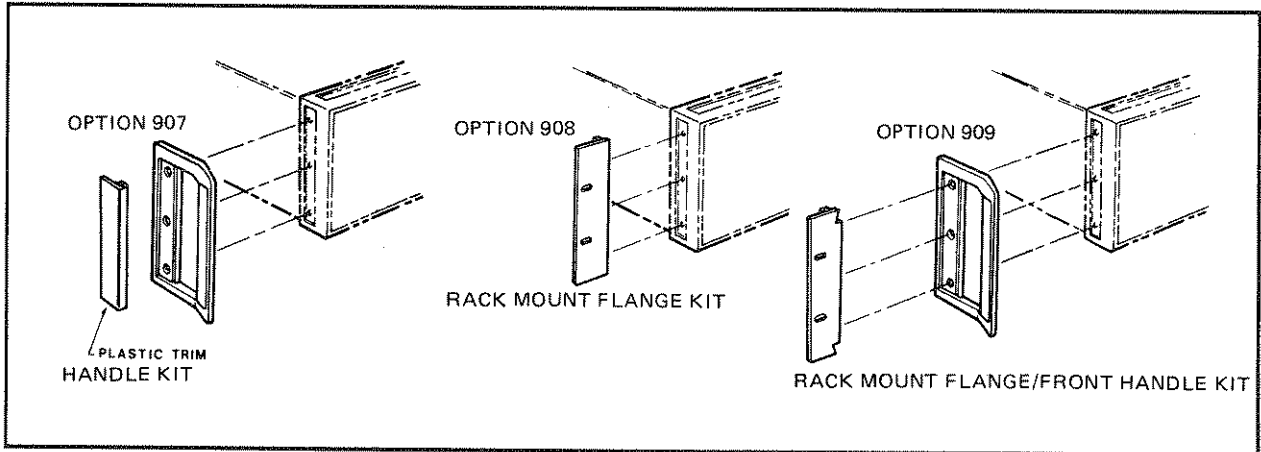

Figure 4-3. Rack Mount and Handle Kits

Option 908 (rack mount flange kit) and 909 (rack mount flange kit with handles) enable the HP 3325B to be mounted in an equipment cabinet. The rack mount for the HP 3325B is EIA standard width of 482.6 mm (19 inches). To install the HP 3325B in an equipment cabinet:

- If installed, remove the plastic trim (see figure 4-3) and front handles from the HP 3325B.
- Remove the plastic feet from the bottom of the HP 3325B.
- Install the rack flange kit with or without handles according to instructions included with the kit. (Kit part numbers are listed in figure 3-3 of the HP 3325B Operation Manual.)

Note The rack mount flange kit of Option 908 will not provide the space requirement for rack mounting when used with the front handle kit of Option 907. If front handles are not available, use the combination kit of Option 909 to rack mount with handles. If Option 907 front handles are available, use Rack Mount Flange Kit, HP part number 5061-2072 to add rack mounting.

- Install an instrument support rail on each side of the instrument cabinet. (The instrument support rails, used to support the weight of the instrument, are included with HP instrument cabinets.)
- Lift the HP 3325B to its position in the cabinet on top of the instrument support rails.
- Using the appropriate screws, fasten the HP 3325B rack mount flanges to the front of the instrument cabinet.

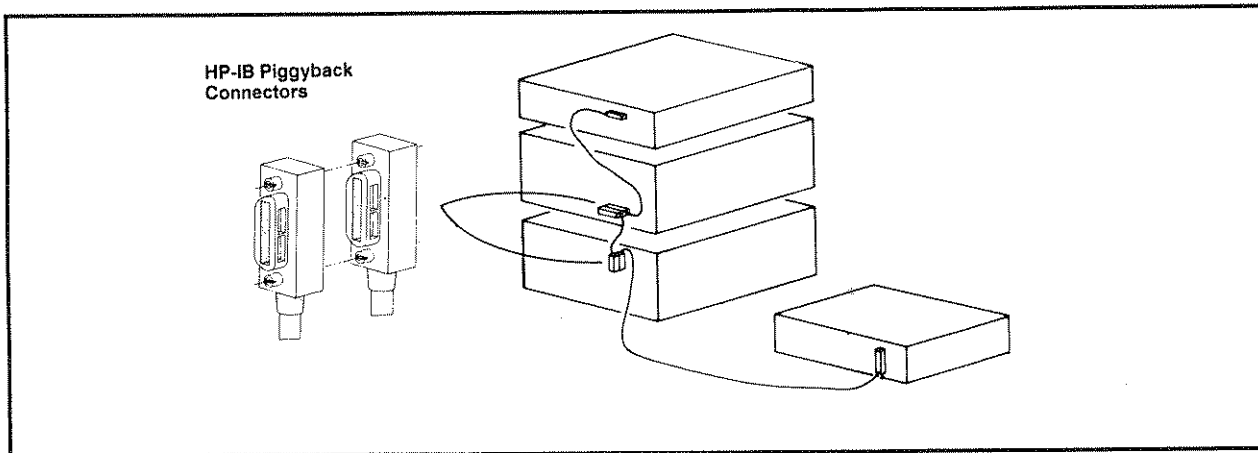

Figure 4-4. Typical HP-IB System Interconnection

HP-IB System Interface Connections

The HP 3325B instrument is compatible with the Hewlett-Packard Interface Bus (HP-IB). The HP-IB is Hewlett-Packard's implementation of IEEE Standard 4881978 and ANSI Standard MC 1.1. The HP 3325B is connected to the HP-IB by connecting an HP-IB interface cable to the connector located on the rear panel. Figure 4-4 illustrates a typical HP-IB system interconnection.

With the HP-IB system, up to 15 HP-IB compatible instruments can be interconnected. The HP 10833 HP-IB cables have identical piggy-back connectors on each end so that several cables can be connected to a single source without special adapters or switch boxes. System components and devices can be connected in virtually any configuration. There must, of course, be a path from the controller to every device operating on the bus. As a practical matter, avoid stacking more than three or four cables on any one connector. If the stack gets too long, any force on the stack can damage the connector mounting. Be sure that each connector is firmly screwed in place to keep it from working loose during use. The HP 3325B uses all the available HP-IB lines, therefore, any damaged connector pins may adversely affect HP-IB operation. Refer to figure 4-5 for a description of the HP-IB connector.

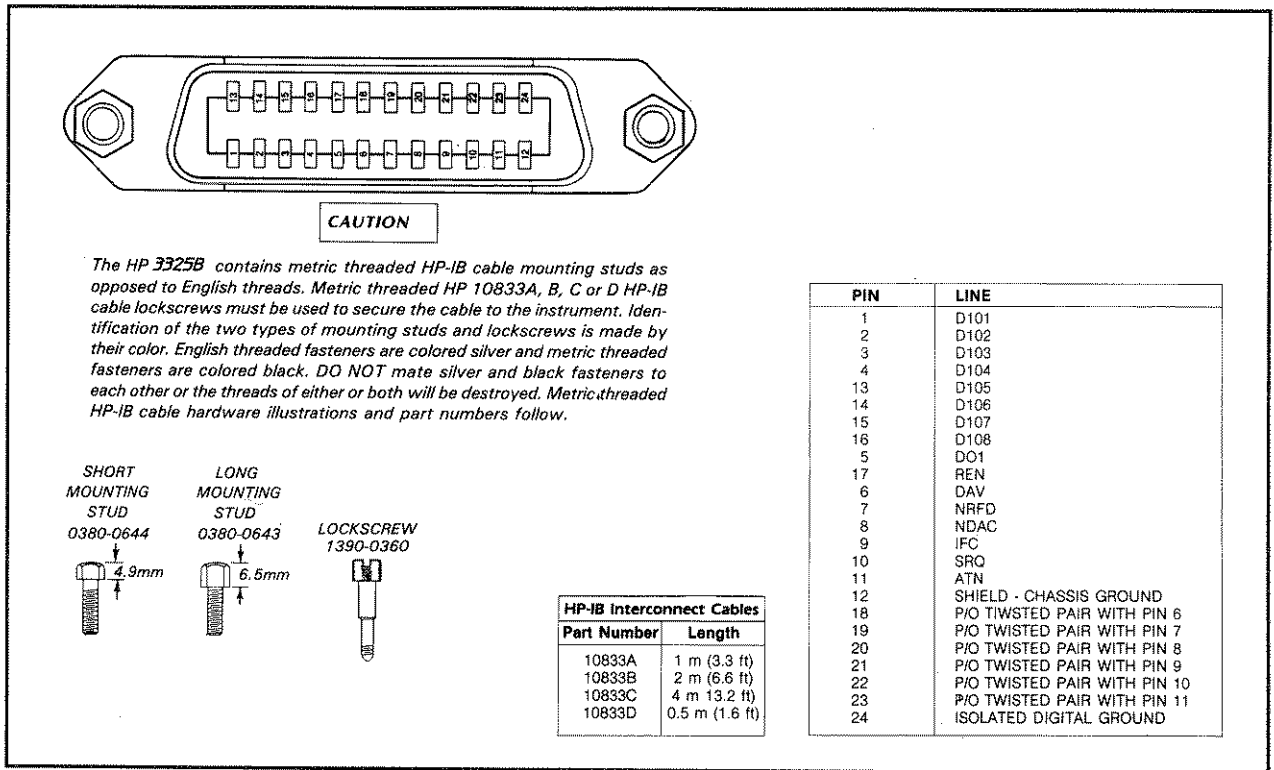

Figure 4-5. HP-IB Connector Information

To achieve design performance with the HP-IB, proper voltage levels and timing relationships must be maintained. If the system cable is too long, the lines cannot be driven properly and the system will fail to perform (see figure 4-5 for HP-IB cable lengths). Therefore, when interconnecting an HP-IB system, it is important to observe the following rule:

Total cable length for the system must be less than or equal to 20 meters (65 feet) or 2 meters (6 feet) times the total number of devices connected to the bus, whichever is less.

Storage And Shipment

The HP 3325B should be stored in a clean, dry environment. The following are environmental limitations that apply to both storage and shipment:

Temperature	- 40°C to +75°C
Humidity	Up to 95%
Altitude	Up to 15,300 meters (50,000 feet)

The HP 3325B should also be protected from temperatures or temperature changes which cause condensation within the instrument.

Containers and materials identical to those used in factory packaging are available through Hewlett-Packard offices. If the instrument is being returned to Hewlett-Packard for service, attach a tag indicating the type of service required, return address, model number, and full serial number. Also, mark the container FRAGILE to ensure careful handling. In any correspondence, refer to the instrument by model number and full serial number.

The following general instructions should be used for repacking with commercially available materials:

- Wrap the instrument in heavy paper or anti-static plastic. If shipping to a Hewlett-Packard office or service center, attach a tag to the instrument indicating type of service required, return address, model number, and full serial number.
- Use a strong shipping container. A double-wall carton made of 350-pound test material is adequate.
- Use a layer of shock absorbing material 70 to 100 mm (3 to 4 inch) thick around all sides of the HP 3325B to provide firm cushioning and prevent movement inside of the container. Protect the control panel with cardboard.

Caution *Styrene pellets in any shape should not be used as packing material. The pellets do not adequately cushion the instrument and do not prevent the instrument from shifting in the carton. The pellets also create static electricity which can damage electronic components.*

- Seal shipping container securely.
- Mark shipping container FRAGILE to ensure careful handling.
- In any correspondence, refer to the instrument by model number and full serial number.

Operational Verification

The following procedures are recommended for incoming inspection and for testing the instrument after repair. Additional tests to be performed following repair of certain circuits are indicated in Section VIII of the *HP 3325B Service Manual*. An Operational Verification Record is located at the end of this section. For ease of recording the test data at various times, copies of the blank Operational Verification Record may be made without written permission from Hewlett-Packard.

Operational Verification includes the following procedures:

- Self Test
- Sine Wave Verification
- Square Wave Verification
- Triangle and Ramp Verification
- Amplitude Flatness Check
- Sync Output Check
- Frequency Accuracy
- Output Level and Attenuator Check
- Harmonic Distortion
- Close-in Spurious Signal

Required Test Equipment

The test equipment required for Operational Verification is listed in table 4-3. Any equipment that satisfies the critical specifications given in the table may be substituted for the recommended model.

Table 4-3. Test Equipment Required for Operational Verification

Instrument	Critical Specifications	Recommended Model
Analog Oscilloscope	Vertical: Bandwidth: dc to 100 MHz Deflection: 0.01 to 5 V/div Horizontal: Sweep: 0.05 μ s to 0.5 s/div \times 10 Magnification Delayed Sweep	HP 1740A/TEK 2245
Electronic Counter	Frequency measurement to 20 MHz Accuracy: \pm 2 counts Resolution: 8 digits	HP 5328A with Opt. 010,040, and 041/5328B with Opt. 010
DC Digital Voltmeter	Ranges: 0.1 to 100V Resolution: 5 1/2 digits Accuracy: \pm 0.1%	HP 3455A/3478A

Table 4-3. Test Equipment Required for Operational Verification (Cont'd)

Instrument	Critical Specifications	Recommended model
50 Ω Feedthru Termination	Accuracy: $\pm 0.2\%$ Power Rating: 1W	HP 11048C
High Frequency Spectrum Analyzer	Frequency Range: 1 to 80 MHz Amplitude Accuracy: ± 0.5 dB Noise: >70 dB below reference	HP 141T/8552B/8553B/ 8566A/8568A
Low Frequency Spectrum Analyzer	Frequency Range: 100 Hz to 50 kHz Amplitude Range: 2 mV to 20V Noise: >80 dB below input reference or -140 dBv	HP 3580A/3585A
Resistor	470 Ω 2W 5%	HP 0698-3634
Resistor	56.2 Ω 1/8W 1.0%	HP 0757-0395
Adapter	BNC female-to-dual banana plug	HP 1251-2277

Self Test

This test uses the control, ROM, and control clock circuits to verify operation of these and other circuits. The following front panel indications result from this test.

LED check: Turns on all LEDs for about two seconds.

The following messages are displayed for about one second:

PASS 0 or FAIL 02*n* – tests Amptd Cal of dc offset.
 PASS 1 or FAIL 02*n* – tests Amptd Cal of sine wave.
 PASS 2 or FAIL 02*n* – tests Amptd Cal of square wave.
 PASS 3 or FAIL 02*n* – tests Amptd Cal of triangle wave.
 (*n* is a number from 0 to 9)

Press the blue [Shift] key, then press the [Amptd Cal] key. All LEDs should light, and the display should not indicate any failures.

Sine Wave Verification

This procedure visually checks the sine wave output for the correct frequency and any visible irregularities.

Equipment Required: Analog Oscilloscope

- a. Connect the HP 3325B signal output to the oscilloscope vertical input. Set the input switch to the 50 Ω position. If your oscilloscope does not have a 50 Ω input, use a 50 Ω feedthru termination at the input.

- b. Set the HP 3325B as follows:
- | | |
|----------------------------------|--------------------|
| High Voltage Output (option 002) | Off |
| Function | Sine |
| Frequency | 20 MHz |
| Amplitude | 10 V _{pp} |
- c. Set the oscilloscope vertical control to 2 V/div, horizontal to 0.05 μ s/div.
- d. The oscilloscope should display one cycle per division, approximately five divisions peak-to-peak.
- e. Change the HP 3325B frequency to 1 MHz.
- f. Change oscilloscope horizontal control to 0.1 μ s/div.
- g. The oscilloscope should display one sine wave having no visible irregularities.
- High Voltage Output (option 002)**
- h. Set the oscilloscope vertical control to 5 V/div.
- i. Set the oscilloscope input switch to 1 M Ω dc coupled position (or disconnect external 50 Ω feedthru termination).
- j. Select the high voltage output on the HP 3325B. A LED near the key indicates that the high voltage output is on.
- k. Change the amplitude to 40 V_{pp}. The oscilloscope should display one sine wave approximately eight divisions peak-to-peak having no visible irregularities.
- l. Turn off the high voltage output.

Square Wave Verification

This procedure checks the square wave output for frequency, rise time, and aberrations.

Equipment Required: Analog Oscilloscope

- a. Connect the HP 3325B signal output to the oscilloscope vertical input. Set the input switch to the 50 Ω position. If your oscilloscope does not have a 50 Ω input, use a 50 Ω feedthru termination at the input.
- b. Set the HP 3325B as follows:
- | | |
|----------------------------------|--------------------|
| High Voltage Output (option 002) | Off |
| Function | Square |
| Frequency | 1 MHz |
| Amplitude | 10 V _{pp} |
- c. Set the oscilloscope vertical control to 2 V/div, horizontal to 0.2 μ s/div. The oscilloscope should display two square waves, approximately five divisions peak-to-peak.

- d. Switch the oscilloscope vertical control to 1 V/div, so that the aberrations (overshoot and ringing) can be measured. Aberration excursion should be less than 500 mV (1/2 div).
- e. Repeat step d at 2 kHz and 0.1 ms/div.
- f. Adjust the oscilloscope vertical and horizontal controls so that the square wave rise time between the 10% and 90% points can be measured. Rise time should be less than 20 ns.

Triangle and Ramp Verification

This procedure checks the triangle and ramp output signals for frequency, shape, and ramp retrace time.

Equipment Required: Analog Oscilloscope

- a. Connect the HP 3325B signal output to the oscilloscope vertical input. Set the input switch to the 50 Ω position. If your oscilloscope does not have a 50 Ω input, use a 50 Ω feedthru termination at the input.
- b. Set the HP 3325B as follows:

High Voltage Output (option 002)	Off
Function	Triangle
Frequency	10 kHz
Amplitude	10 V _{pp}
- c. Set the oscilloscope vertical control to 2 V/div, horizontal to 0.1 ms/div. The oscilloscope should display one triangle wave per division, approximately five divisions peak-to-peak.
- d. Change the HP 3325B function to positive slope ramp. The display should be one ramp per division, approximately five divisions peak-to-peak.
- e. Change the function to negative slope ramp. The display should be one ramp per division, approximately five divisions peak-to-peak.
- f. Change the oscilloscope horizontal and vertical controls so that the ramp retrace time from the 90% to 10% points can be measured. Retrace time should be less than 3 μ s.
- g. Change the HP 3325B function to positive slope ramp and repeat step f.
- h. Change the function to triangle.
- i. Set oscilloscope vertical control to 2 V/div, horizontal to 10 μ s/div. The oscilloscope should display one triangle wave with no visible irregularities in either slope.

Amplitude Flatness Check

This procedure provides a visual check of the sine wave amplitude flatness.

Equipment Required: Analog Oscilloscope

- a. Connect the HP 3325B signal output to the oscilloscope vertical input. Set the input switch to the 50 Ω position. If your oscilloscope does not have a 50 Ω input, use a 50 Ω feedthru termination at the input.

- b. Set the HP 3325B as follows:

High Voltage Output (option 002)	Off
Function	Sine
Frequency	2 kHz
Amplitude	10 V _{pp}
Sweep Start Freq	0 Hz
Sweep Stop Freq	20 MHz
Sweep Marker Freq	5 MHz
Sweep Time	0.01 sec

- c. Connect the HP 3325B X-Drive output to the oscilloscope channel B input. Connect the signal output to the oscilloscope channel A input.

- *d. Set the oscilloscope as follows:

Display	A vs B
Channel A Sensitivity (uncal – adjust for full vertical deflection)	1 V/div
Channel B Sensitivity (uncal – adjust for full horizontal sweep)	0.5 V/div

**Settings may vary from one oscilloscope to another. Note that whichever oscilloscope is used, it should be operated in a X-Y mode with the HP 3325B X-Drive output driving the horizontal (X) channel and the signal output driving the vertical (Y) channel.*

- e. Press the HP 3325B [Start Cont] key.
- f. The oscilloscope display should show a sweep that is essentially flat, dropping no more than 3.5%. Any dc variations should be ignored, taking the peak-to-peak reading for flatness comparison.

Sync Output Check

This test verifies the sync output signal levels.

Equipment Required: Analog Oscilloscope

- a. Connect the HP 3325B sync output to the oscilloscope vertical input. Set the input switch to the 50 Ω position. If your oscilloscope does not have a 50 Ω input, use a 50 Ω feedthru termination at the input.
- b. Set the HP 3325B function to sine, frequency to 20 MHz.
- c. Adjust the oscilloscope controls to measure the high and low voltage levels of the sync square wave. The high level should be greater than +1.2V and the low level should be less than +0.2V.

Frequency Accuracy

This test compares the accuracy of the HP 3325B output signal to the following specification:

$$\pm 5 \times 10^{-6} \text{ of selected frequency (20}^\circ\text{C to 30}^\circ\text{C).}$$

Equipment Required: Electronic Counter (calibrated within three months or with an accurate 10 MHz external reference input)

- a. Connect the HP 3325B signal output to the electronic counter channel A input with a 50 Ω feedthru termination. Allow HP 3325B to warm up for 20 minutes and the counter to warm up for its specified period.
- b. Set the HP 3325B output as follows:

Function	Sine
Frequency	20 MHz
Amplitude	0.99 V _{pp}
DC Offset	0V
- c. Set the counter to count the frequency of the A input with 0.1 Hz resolution, and adjust for stable triggering. Electronic counter should indicate 20 000 000.0 Hz \pm 100 Hz.
- d. Change the HP 3325B function to square wave. Frequency automatically changes to 10 MHz. Electronic counter should indicate 10 000 000.0 Hz \pm 50 Hz.
- e. Change the function to triangle. Frequency automatically changes to 10 kHz. Move the counter input to the sync output of the HP 3325B. Set the counter to average 1000 periods. Electronic counter should indicate 100 000.00 ns \pm 0.5 ns.
- f. Change the function to positive slope ramp. Electronic counter should indicate 100 000.00 ns \pm 0.5 ns.

Output Level and Attenuator Check

This procedure checks the output level and the attenuator by using the "dc only" function.

Equipment Required: DC Digital Voltmeter
50 Ω Feedthru Termination

- a. Connect the HP 3325B signal output directly to a 50 Ω feedthru termination and then with a cable to the voltmeter input.
- b. If the instrument has high voltage output (option 002), make sure the high voltage output is off (high voltage indicator light in the lower right corner of the front panel is off).
- c. Press whichever function key is presently active, indicated by a lighted indicator beside the key. This removes the ac output. The indicator beside the [DC Offset] key should light.
- d. Set the HP 3325B dc offset to -5V, then press the [Amptd Cal] key.

- e. The voltmeter reading should be -4.980 to -5.020 V.
- f. Change the HP 3325B dc offset to $+5$ V. Voltmeter reading should be $+4.980$ to $+5.020$ V.
- g. Change the HP 3325B dc offset to the following voltages. The voltmeter reading should be within the tolerances shown.

DC Offset	Tolerances
± 1.499 V	± 1.49300 to 1.50499 V
± 499.9 mV	± 0.49790 to 0.50190 V
± 149.9 mV	± 0.14930 to 0.15050 V
± 49.99 mV	± 0.04979 to 0.05019 V
± 14.99 mV	± 0.01493 to 0.01505 V
± 4.999 mV	± 0.004979 to 0.005019 V
± 1.499 mV	± 0.001479 to 0.001519 V

High Voltage Output (option 002) DC Offset

- h. Remove the 50Ω feedthru termination and connect the HP 3325B output directly to the voltmeter input.
- i. Select high voltage output on the HP 3325B. A LED near the key indicates that high voltage output is on.
- j. Set the HP 3325B dc offset to 20 V. Voltmeter reading should be $+19.775$ to $+20.225$ V.
- k. Set the HP 3325B dc offset to -20 V. Voltmeter reading should be -19.775 to -20.225 V.

Harmonic Distortion

This procedure tests the harmonic distortion of the HP 3325B sine wave output to the following specifications:

Harmonic Distortion (relative to fundamental)

Fundamental Frequency	No Harmonic Greater Than
0.1 Hz to 50 kHz	-65 dB
50 to 200 kHz	-60 dB
200 kHz to 2 MHz	-40 dB
2 to 15 MHz	-30 dB
15 to 20 MHz	-25 dB

Equipment Required: High Frequency Spectrum Analyzer
 Low Frequency Spectrum Analyzer
 50Ω Feedthru Termination
 Resistor 470Ω 2W 5%
 Resistor 56.2Ω 1/8W 1%

- a. Set the HP 3325B output as follows:

High Voltage Output (option 002)	Off
Function	Sine
Frequency	20 MHz
Amplitude	999 mV _{pp}
- b. Connect the HP 3325B signal output to the high frequency spectrum analyzer 50Ω input.
- c. Set the spectrum analyzer controls to display the fundamental and at least four harmonics. Verify that all harmonics are 25 dB below the fundamental.
- d. Set the HP 3325B to 15 MHz and verify that all harmonics are at least 30 dB below the fundamental.
- e. Disconnect the HP 3325B from the high frequency spectrum analyzer and connect it to the low frequency spectrum analyzer 50Ω input. Set the HP 3325B to the following frequencies and verify the specified levels, relative to the fundamental.

2 MHz	-40 dB
200 kHz	-60 dB
- f. Set the HP 3325B frequency to 50 kHz and the amplitude to 9.99 mV_{pp}.
- g. Set the spectrum analyzer controls to display the fundamental and at least three harmonics. (It may be necessary to decrease the video bandwidth to separate the harmonics from the noise floor.) Verify that all harmonics are at least 65 dB below the fundamental.
- h. Set the HP 3325B to the following frequencies and verify that all harmonics are 65 dB below the fundamental.

10 kHz	
1 kHz	
100 Hz	

High Voltage Output (option 002)
- i. Connect the HP 3325B signal output to the low frequency spectrum analyzer high impedance input (see figure 4-6).
- j. Select the high voltage output on the HP 3325B. Set the amplitude to 40 V_{pp} and the frequency to 100 Hz.
- k. Set the spectrum analyzer controls to display the fundamental and at least three harmonics. Verify that all harmonics are 65 dB below the fundamental.
- l. Set the HP 3325B to the following frequencies and verify that their harmonics are below the specified levels, relative to the fundamental.

10 kHz	-65 dB
200 kHz	-60 dB
1 MHz	-40 dB
- m. Turn off the high voltage output.

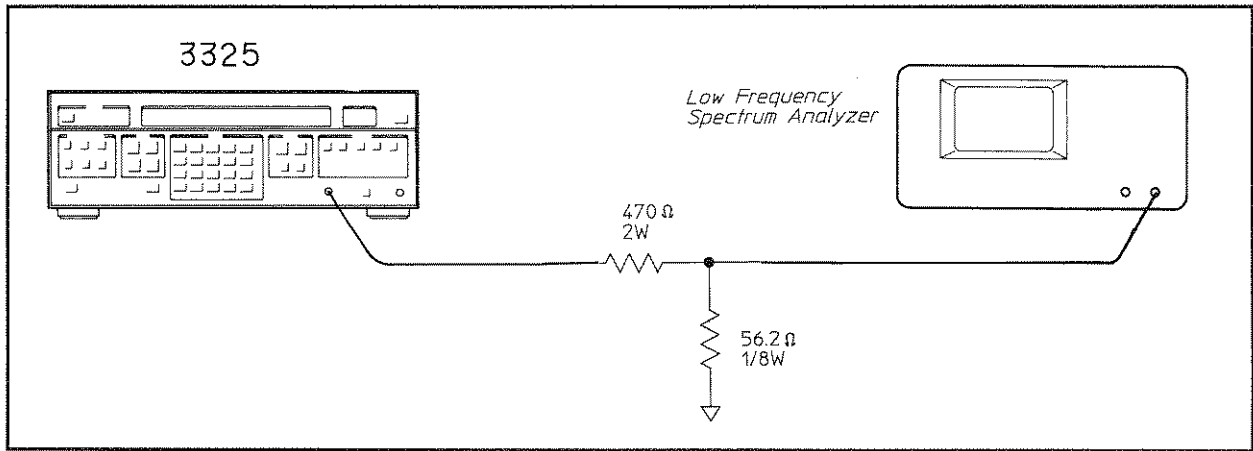

Figure 4-6. Harmonic Distortion Verification (High Voltage Output).

Close-In Spurious Signal

This procedure tests the sine wave output for spurious signals which may be generated by the HP 3325B frequency synthesis circuits. The spurious signals must be more than 70 dB lower than the fundamental signal.

Equipment Required: Spectrum Analyzer

- a. Set the HP 3325B as follows:

High Voltage Output (option 002)	Off
Function	Sine
Frequency	20.001 MHz
Amplitude	-2.99 dBm
DC Offset	0V
- b. Connect the HP 3325B signal output to the spectrum analyzer 50Ω input.
- c. Set the spectrum analyzer controls for a center frequency of 20.001 MHz, a resolution bandwidth of 30 Hz, a frequency span of 100 Hz/div, and the fundamental referenced to the top of the display graticule.
- d. Set the spectrum analyzer center frequency to 20.002, 20.003, and 20.004 MHz, verifying in each case that all spurious signals are more than 70 dB below the fundamental.

Performance Tests

The following procedures compare the instrument operation to its specifications listed in Appendix A. Performance Test Records are located at the end of this section. These test records lists all of the tested specifications and acceptable limits. For ease of recording data at various times, copies of the blank Performance Test Records may be made without written permission from Hewlett-Packard.

The Performance Tests include the following:

- Harmonic Distortion
- Spurious Signal
- Integrated Phase Noise
- Amplitude Modulation Envelope Distortion
- Square Wave Rise Time and Aberrations
- Ramp Retrace Time
- Sync Output
- Square Wave Symmetry
- Frequency Accuracy
- Phase Increment Accuracy
- Phase Modulation Linearity
- Amplitude Accuracy
- DC Offset Accuracy (DC Only)
- DC Offset Accuracy with AC Functions
- Triangle Linearity
- X Drive Linearity
- Ramp Period Variation

Required Test Equipment

The test equipment required for the Performance Tests is listed in table 4-4. Any equipment that satisfies the critical specifications given in the table may be substituted for the recommended model.

Table 4-4. Test Equipment Required for Performance Tests.

Instrument	Critical Specifications	Recommended Model
Analog Oscilloscope	Vertical Bandwidth: dc to 100 MHz Deflection: 0.01 to 5 V/div Horizontal Sweep: 0.05 μ s to 0.5 s/div $\times 10$ Magnification Delayed Sweep	HP 1740A/TEK 2245
Sampling Oscilloscope	Vertical Deflection: 2 mV/div Horizontal Sweep: 10 ps to 50 μ s/div Transient response Aberrations: < +0.5%, - 3% Vpp first 5 ns following step transition < $\pm 1\%$ Vpp after 5 ms	TEK 7603* with 7T11/ 7S11 and S-1
Electronic Counter	Frequency measurement Frequency Range: to 20 MHz Resolution: 8 digits Accuracy: ± 2 counts Time Interval Average A to B Resolution: 0.01 ns	HP 5328A with Opt. 010, 040, and 041/5328B with Opt. 010
AC/DC Digital Voltmeter	AC Function (True RMS) Ranges: 1 to 100 V Accuracy : $\pm 0.2\%$ Resolution: 5 1/2 digits Crest Factor: 4:1 DC Functions Ranges: 0.1 to 100 V Accuracy: $\pm 0.05\%$ Resolution: 5 1/2 digits	HP 3455A\3478A
50 Ω Feedthru Termination	Accuracy: $\pm 0.2\%$ Power Rating: 1W	HP 11048C
High Frequency Spectrum Analyzer	Frequency Range: 1 kHz to 80 MHz Amplitude Accuracy: ± 0.5 dB Noise: > 70 dB below reference	HP 141T/8552B/8553B/ 8566A/8568A
Low Frequency Spectrum Analyzer	Frequency Range: 20 Hz to 50 kHz Amplitude Accuracy: ± 0.5 dB Spurious Responses: 80 dB below reference	HP 3580A/3585A

(*) This equipment is only necessary to perform the Square Wave Rise Time and Aberrations test.

Table 4-4. Test Equipment Required for Performance Tests. (Cont'd)

Instrument	Critical Specifications	Recommended Model
Frequency Synthesizer	Frequency Range: 100 kHz to 21 MHz Amplitude Range: to +13.01 dBm Output Impedance: 50Ω Phase Noise (Integrated): 9.9 MHz: < - 63 dB 20 MHz: < - 70 dB Spurious: > 75 dB below fundamental	HP 3335A
Double Balanced Mixer	Impedance: 50Ω Frequency Range: 1 - 20 MHz	HP 10534A
1 MHz Low Pass Filter	Cut-off Frequency: 1 MHz Stopband Atten: 50 dB by 4 MHz Stopband Freq: 4 - 80 MHz	Model J903 TTE Inc. 2214 S. Benny Ave. Los Angeles, CA 90064
15 kHz Filter	Consisting of: Resistor: 10 kΩ 1% Capacitor: 1600 pF 5%	HP 0757-0340 HP 0160-2223
AC Voltmeter	Ranges: 0.1 to 1 V Frequency Range: 20 Hz - 1 MHz Input Impedance: ≥1 MΩ Meter: Log scale Acc (100 Hz to 10 kHz): ±1%	HP 400FL/3400A
Sine Wave Signal Source	Frequency: 10 kHz Amplitude: 1 Vrms into 20 kΩ Distortion: -60 dB	HP 204C/3325/3336
DC Power Supply	Volts: 0 to ±5 V Amps: 10 mA Floating Output	HP 6214A/6214B
Thermal Converter	Input Impedance: 50Ω Input Voltage: 1 Vrms Frequency: 2 kHz to 20 MHz Frequency Response: ±0.05 dB 2 kHz to 20 MHz	HP 11050A/Ballantine Model 1395A-1 with cable 12577A Opt. 10 Ballantine Labs, Inc. P. O. Box 97 Boonton, NJ 07005
Resistive Divider	Consisting of: 2 Resistors: 61.11Ω 0.1% 1/4W 2 Resistors: 36.55Ω 0.1% 1/8W	HP 0699-0090 HP 0698-7169
Resistive Divider	Consisting of: Capacitor: 300 pF 5% 3 Resistors: 1330Ω 0.1% 1/4W Resistor: 43Ω 0.1% 1/8W	HP 0160-2207 HP 0698-7453 HP 0698-8264

Table 4-4. Test Equipment Required for Performance Tests. (Cont'd)

Instrument	Critical Specifications	Recommended Model
High-Speed DC Digital Voltmeter	DC Voltage: 0 to ± 10 V External Trigger: Low True TTL Edge Trigger Trigger Delay: Selectable 10 to 140 μ s	HP 3437A
BNC-to-Triax Adapter	Female BNC to Male Triax	HP 1250-0595
Resistive Divider $\div 2.5$	Consisting of: Resistor: 30 Ω 1% 1/4W Resistor: 20 Ω 1% 1/4W	HP 0698-7533 HP 0698-6296
Resistive Divider $\div 2.6$	Consisting of: Resistor: 100 k Ω 1% 1/8W Resistor: 162 k Ω 1% 1/8W	HP 0757-0465 HP 0757-0470
Resistor	470 Ω 2W 5%	HP 0698-3634
Resistor	56.2 Ω 1/8W 1.0%	HP 0757-0395
Adapter	BNC female to dual banana plug BNC Tee	HP 1251-2277 HP 1250-0781
Step Attenuator	0 – 12 dB; 1 dB steps 0 – 40 dB	HP 355C HP 355D*

(*) This equipment is only necessary to perform the Square Wave Rise Time and Aberrations test.

Harmonic Distortion

This procedure tests the harmonic distortion of the HP 3325B sine wave output to the following specifications:

Harmonic Distortion (relative to fundamental)

Fundamental Frequency	No Harmonic Greater Than
0.1 Hz to 50 kHz	-65 dB
50 to 200 kHz	-60 dB
200 kHz to 2 MHz	-40 dB
2 to 15 MHz	-30 dB
15 to 20 MHz	-25 dB

Equipment Required: High Frequency Spectrum Analyzer
Low Frequency Spectrum Analyzer
50 Ω Feedthru Termination
Resistor 470 Ω 2W 5%
Resistor 56.2 Ω 1/8W 1%

Performance Tests

- a. Set the HP 3325B output as follows:
- | | |
|----------------------------------|----------------------|
| High Voltage Output (option 002) | Off |
| Function | Sine |
| Frequency | 20 MHz |
| Amplitude | 999 mV _{pp} |
- b. Connect the signal output to the high frequency spectrum analyzer 50Ω input.
- c. Set the spectrum analyzer controls to display the fundamental and at least four harmonics. Verify that all harmonics are 25 dB below the fundamental.
- d. Set the HP 3325B to 15 MHz and verify that all harmonics are at least 30 dB below the fundamental.
- e. Disconnect the HP 3325B from the high frequency spectrum analyzer and connect it to the low frequency spectrum analyzer 50Ω input. Set the HP 3325B to the following frequencies and verify the specified levels, relative to the fundamental.
- | | |
|---------|--------|
| 2 MHz | -40 dB |
| 200 kHz | -60 dB |
- f. Set the HP 3325B frequency to 50 kHz and the amplitude to 9.99 mV_{pp}.
- g. Set the spectrum analyzer controls to display the fundamental and at least three harmonics. (It may be necessary to decrease the video bandwidth to separate the harmonics from the noise floor.) Verify that all harmonics are at least 65 dB below the fundamental.
- h. Set the HP 3325B to the following frequencies and verify that all harmonics are 65 dB below the fundamental.
- | | |
|--------|--|
| 10 kHz | |
| 1 kHz | |
| 100 Hz | |
- High Voltage Output (option 002)**
- i. Connect the HP 3325B signal output to the low frequency spectrum analyzer high impedance input (see figure 4-6).
- j. Select the high voltage output on the HP 3325B. Set the amplitude to 40 V_{pp} and the frequency to 100 Hz.
- k. Set the spectrum analyzer controls to display the fundamental and at least three harmonics. Verify that all harmonics are 65 dB below the fundamental.
- l. Set the HP 3325B to the following frequencies and verify that their harmonics are below the specified level, relative to the fundamental.
- | | |
|---------|--------|
| 10 kHz | -65 dB |
| 200 kHz | -60 dB |
| 1 MHz | -40 dB |
- m. Turn off the high voltage output.

Spurious Signal

This procedure tests the HP 3325B sine wave output for spurious signals. Circuits within the HP 3325B may generate repetitive frequencies that are not harmonically related to the fundamental output frequency. All spurious signals must be more than 70 dB below the fundamental signal or less than -90 dBm, whichever is greater.

Equipment Required: Spectrum Analyzer

Mixer Spurious

- a. Connect the HP 3325B signal output to the spectrum analyzer 50Ω (RF) input and the HP 3325B EXT REF input to the analyzer 10 MHz reference output (see figure 4-7).
- b. Set the HP 3325B as follows:

Function	Sine
Amplitude	-20 dBm
Frequency	2.001 MHz
- c. Set the analyzer controls as follows:

Center Frequency	2.001 MHz
Frequency Span	1 kHz
Video BW	100 Hz
Resolution BW	30 Hz
- d. Adjust the spectrum analyzer to reference the fundamental to the top display graticule.
- e. Without changing the reference level, change the spectrum analyzer center frequency to 27.999 MHz to display the 2:1 mixer spur. Verify that this spur is at least 70 dB below the fundamental.
- f. Change the spectrum analyzer center frequency to 25.998 MHz to display the 3:2 mixer spur. Verify that this spur is at least 70 dB below the fundamental.
- g. In a similar manner, change the HP 3325B frequency and the spectrum analyzer center frequency to the following frequencies. For each setting, verify that all spurious signals are 70 dB below the fundamental.

HP 3325B	Spectrum Analyzer Center Frequency	
	2:1 Spur	3:2 Spur
4.100 MHz	25.9 MHz	21.8 MHz
6.100 MHz	23.9 MHz	17.8 MHz
8.100 MHz	21.9 MHz	13.8 MHz
10.100 MHz	19.9 MHz	9.8 MHz
12.100 MHz	17.9 MHz	5.8 MHz
14.100 MHz	15.9 MHz	1.8 MHz
16.100 MHz	13.9 MHz	2.2 MHz
18.100 MHz	11.9 MHz	6.2 MHz
20.100 MHz	9.9 MHz	10.2 MHz

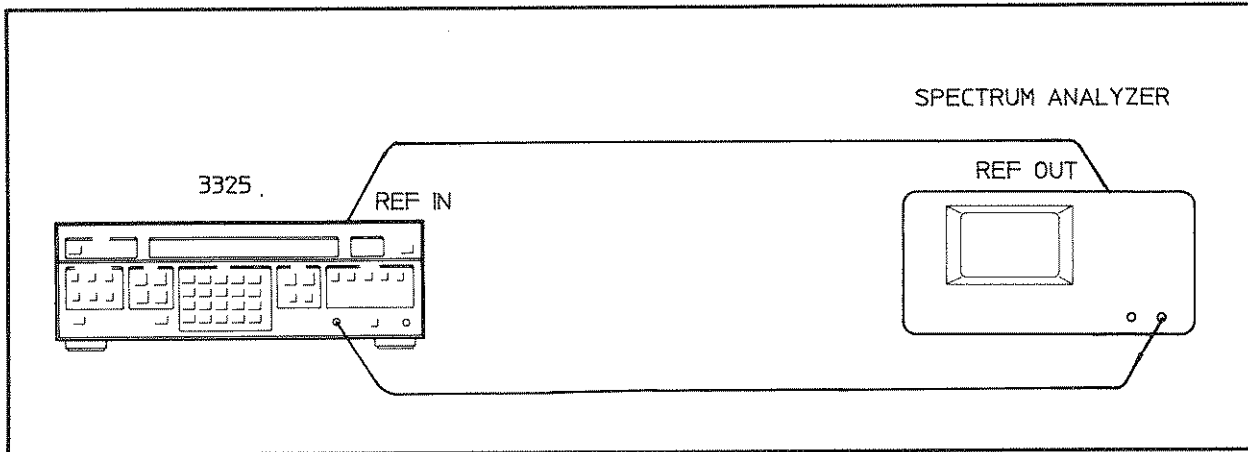

Figure 4-7. Mixer Spurious.

Close-in Spurious (Fractional N Spurs)

- h. Set the HP 3325B frequency to 5.001 MHz and the amplitude to -2.99 dBm.
- i. Set the spectrum analyzer controls as follows:

Center Frequency	5.001 MHz
Frequency Span	1 kHz
Video BW	100 Hz
Resolution BW	30 Hz
- j. Adjust the spectrum analyzer to reference the fundamental to the top display graticule.
- k. Without changing the reference level, change the spectrum analyzer center frequency to 5.002 MHz to display the API 1 spur. It may be necessary to decrease the video bandwidth to optimize the display resolution.
- l. All spurious (non-harmonic) signals should be at least 70 dB below the fundamental.
- m. Without changing the reference level, set the HP 3325B frequency and the spectrum analyzer center frequency to the frequencies listed below. For each setting, verify that all spurious signals are at least 70 dB below the fundamental.

HP 3325B	Spectrum Analyzer Center Frequency
5.0001 MHz	5.0011 MHz
5.00001 MHz	5.00101 MHz
5.000001 MHz	5.001001 MHz
20.001 MHz	20.002 MHz
20.001 MHz	20.003 MHz
20.001 MHz	20.004 MHz
20.001 MHz	20.005 MHz

Integrated Phase Noise

This test compares the HP 3325B integrated phase noise to the following specification:

–60 dB for a 30 kHz band centered on a 20 MHz carrier (excluding ± 1 Hz about the carrier).

Equipment Required: Frequency Synthesizer
 Double Balanced Mixer
 50 Ω Feedthru Termination
 AC/DC Digital Voltmeter
 AC Voltmeter
 15 kHz noise equivalent filter consisting of:
 Resistor: 10 k Ω \pm 1%
 Capacitor: 1600 pF \pm 5% (see figure 4-8)
 1 MHz Low Pass Filter

- a. Connect the equipment as shown in figure 4-8, connecting the 15 kHz noise equivalent filter output to the ac voltmeter. Phase lock the HP 3325B and the signal generator together.
- b. Set the HP 3325B as follows:

Function	Sine
Frequency	19.901 MHz
Amplitude	0 dBm
- c. Set the synthesizer (reference) as follows:

Frequency	19.9 MHz
Amplitude	+7.00 dBm
- d. Record the ac voltmeter reading (dB scale).
- e. Change the HP 3325B frequency to 19.9 MHz.
- f. Connect the 15 kHz filter output to the digital voltmeter.
- g. Press the HP 3325B [Phase] key. Using the modify keys, adjust the output phase for a minimum reading on the digital voltmeter.
- h. Disconnect the 15 kHz filter output from the digital voltmeter and connect it to the ac voltmeter.
- i. Record the ac voltmeter reading (dB scale) and subtract it from the reading recorded in step d. The difference should be –54 dB or greater. Add –6 dB to this number and enter on the Performance Test Record. The 6 dB is a correction factor compensating for the folding action of the mixer.

NOTE Frequencies used minimize the phase noise contribution of the frequency synthesizer.

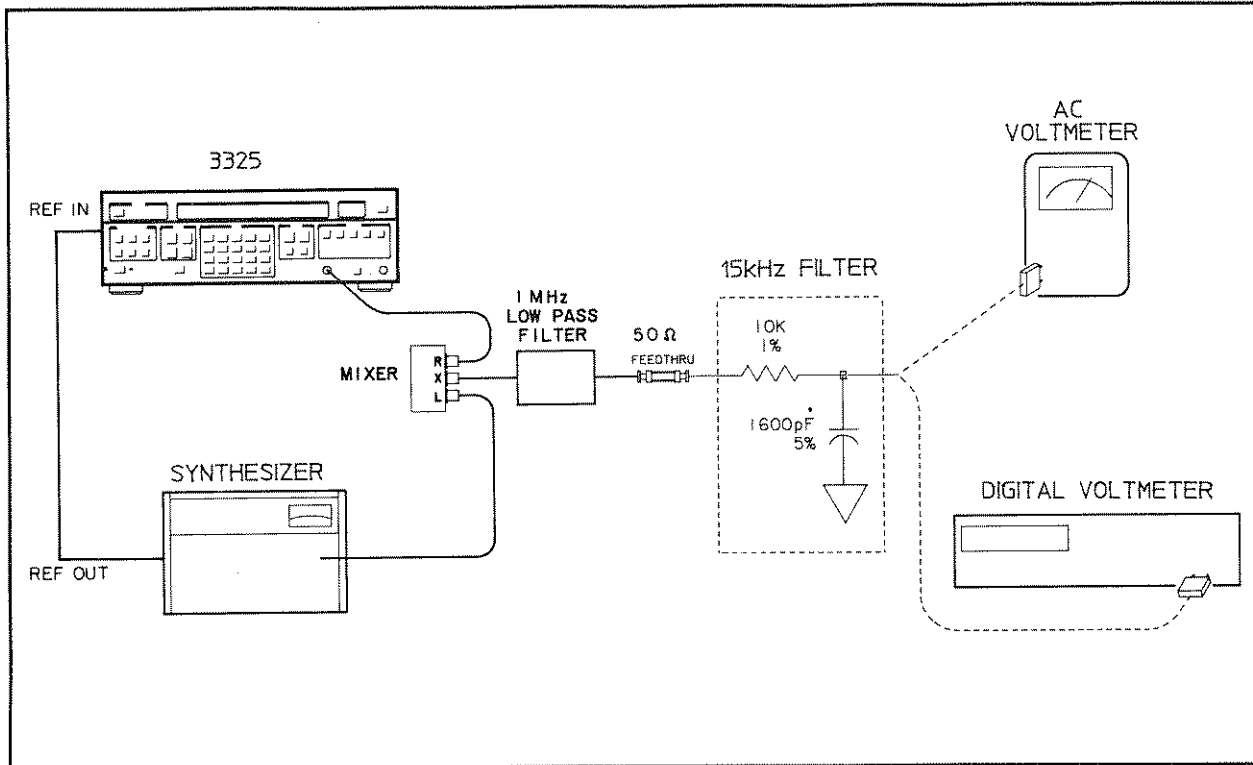

Figure 4-8. Integrated Phase Noise.

Amplitude Modulation Envelope Distortion

This procedure tests the HP 3325B amplitude modulation envelope distortion to the following specification:

–30 dB to 80% modulation at 1 kHz, 0V dc offset

Equipment Required: Sine Wave Signal Source
Spectrum Analyzer

- a. Connect the equipment as shown in figure 4-9.
- b. Set the HP 3325B output as follows:

Function	Sine
Frequency	1 MHz
Amplitude	3 V _{pp}
DC Offset	0V
High Voltage Output (option 002)	Off
AM	On

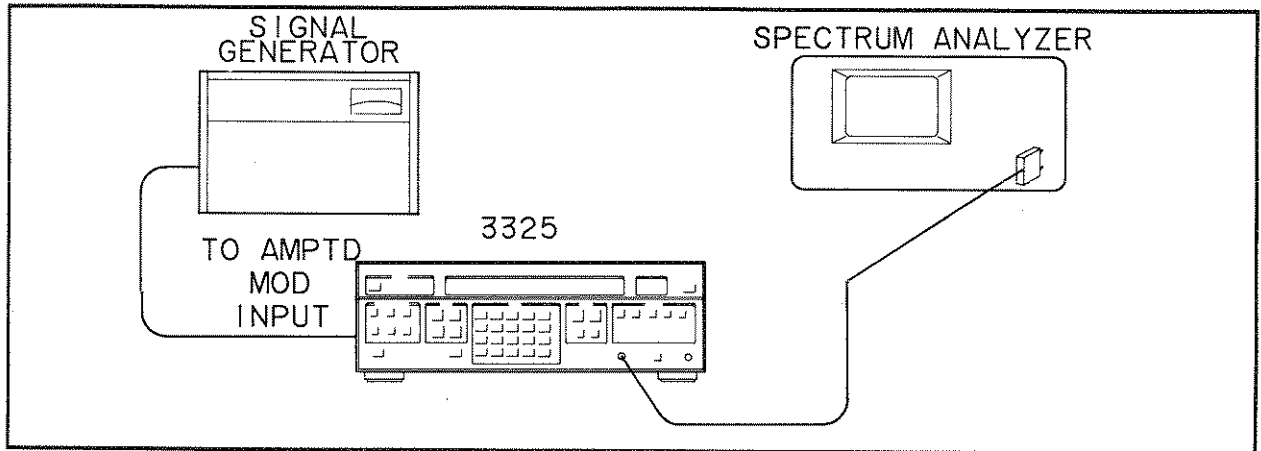

Figure 4-9. AM Envelope Distortion.

- c. Set the modulating signal source frequency to 1 kHz and adjust the level to produce 80% modulation of the HP 3325B output. This is indicated by modulation sidebands being 8.0 dB down from the carrier, as viewed on the 2 dB/div display of the spectrum analyzer.
- d. Adjust the spectrum analyzer to display the fundamental frequency, the 1 kHz sideband frequency, and at least 4 harmonics of the sidebands. All harmonics should be at least 30 dB lower than the modulation sidebands.

Square Wave Rise Time and Aberrations

This procedure compares the HP 3325B square wave output to its rise/fall time and overshoot specifications.

Rise and Fall Time: ≤ 20 ns, 10% to 90% at full output

Overshoot: $\leq 5\%$ of peak-to-peak amplitude at full output

Equipment Required: Sampling Oscilloscope
40 dB Attenuator

- a. Connect the HP 3325B signal output to the attenuator input and the attenuator output to the oscilloscope input. Set the attenuator for 40 dB attenuation.
- b. Set the HP 3325B as follows:

High Voltage Output (option 002)	Off
Function	Square
Frequency	1 MHz
Amplitude	10 V _{pp}

- c. Adjust the oscilloscope vertical and horizontal controls so that the square wave rise time between the 10% and 90% points can be measured. Rise time should be less than 20 ns.
- d. Adjust the oscilloscope vertical and horizontal controls so that the square wave fall time between the 10% and 90% points can be measured. Fall time should be less than 20 ns.
- e. Adjust the oscilloscope vertical and horizontal controls so that the square wave overshoot can be measured. Overshoot should be less than 500 mV at positive and negative peaks.

Ramp Retrace Time

This test compares the HP 3325B retrace time of the positive and negative slope ramps to the following specification:

$$\leq 3 \mu\text{s } 90\% \text{ to } 10\%$$

Equipment Required: Analog Oscilloscope

- a. Connect the HP 3325B signal output to the oscilloscope vertical input. Set the input switch to the 50 Ω position. If your oscilloscope does not have a 50 Ω input, use a 50 Ω feedthru termination at the input.
- b. Set the HP 3325B as follows:

High Voltage Output (option 002)	Off
Function	Positive Slope Ramp
Frequency	10 kHz
Amplitude	10 V _{pp}
- c. Adjust the oscilloscope vertical and horizontal controls so that the ramp retrace time from the 90% to 10% points can be measured. Retrace time should be less than 3 μs .
- d. Change function to negative slope ramp and repeat step c.

Sync Output

This procedure checks the voltage levels of the square wave on the HP 3325B front and rear panel sync outputs to the following specifications:

$$V_{\text{high}} > +1.2\text{V}; V_{\text{low}} < +0.2\text{V into } 50\Omega$$

Equipment Required: Analog Oscilloscope

- a. Connect the HP 3325B front sync output to the oscilloscope vertical input. Set the input switch to the 50 Ω position. If your oscilloscope does not have a 50 Ω input, use a 50 Ω feedthru termination at the input.
- b. Set the HP 3325B function to sine, frequency to 20 MHz.

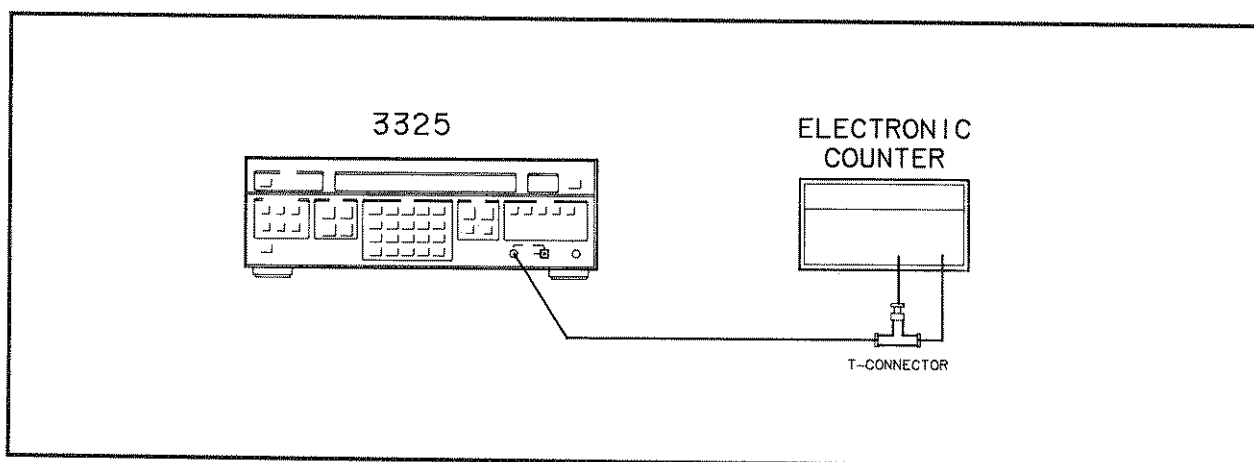

Figure 4-10. Square Wave Symmetry.

- c. Adjust the oscilloscope controls to measure the high and low levels of the sync square wave. The high level should be greater than +1.2V and the low level should be less than +0.2V.
- d. Repeat the measurement for the rear panel FAST[™] sync output. The high level should be greater than +1.5V and the low level less than +0.5V.

Square Wave Symmetry

This procedure checks the symmetry of the HP 3325B square wave signal output to the following specification:

$\leq 0.02\%$ of period +3 nanoseconds

Equipment Required: Electronic Counter

- a. Connect the HP 3325B signal output to both inputs of the electronic counter, using a BNC tee (see figure 4-10).
- b. Set the HP 3325B output as follows:

Function	Square
Frequency	1 MHz
Amplitude	1 Vrms
DC Offset	0V
- c. Adjust the electronic counter to measure time interval average A to B, with Slope A +, Slope B -. Note the reading.
- d. Change Slope A to -, Slope B to +. Reading should be equal to the reading in step c $\pm < 3.2$ ns.

FAST[™] is a trademark of Fairchild Semiconductor Corporation.

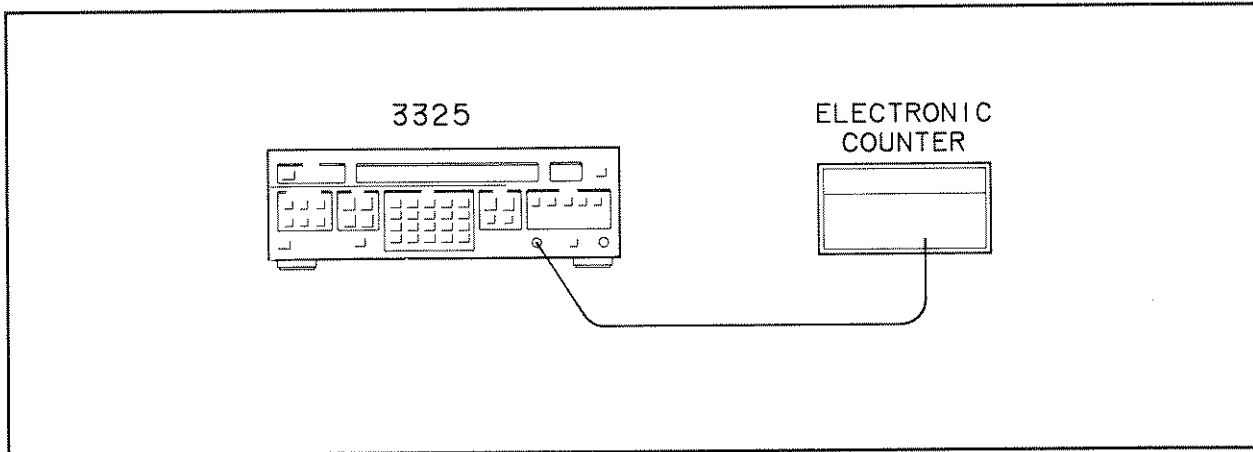

Figure 4-11. Frequency Accuracy.

Frequency Accuracy

This test compares the accuracy of the HP 3325B output signal to the following specifications:

$$\pm 5 \times 10^{-6} \text{ of selected frequency (20}^\circ\text{C to 30}^\circ\text{C).}$$

Equipment Required: Electronic Counter (calibrated within three months or with an accurate 10 MHz external reference input)

- a. Connect the HP 3325B signal output to the electronic counter channel A input with a 50Ω feedthru termination. Allow the HP 3325B to warm up for 20 minutes and the counter's frequency reference to warm up for its specified period.
- b. Set the HP 3325B output as follows:

Function	Sine
Frequency	20 MHz
Amplitude	0.99 V _{pp}
DC Offset	0V
- c. Set the counter to count the frequency of the A input with 0.1 Hz resolution, and adjust for stable triggering. Electronic counter should indicate 20 000 000.00 Hz ± 100 Hz.
- d. Change the HP 3325B function to square wave. Frequency automatically changes to 10 MHz. Electronic counter should indicate 10 000 000.0 Hz ± 50 Hz.
- e. Change the HP 3325B function to triangle. Frequency automatically changes to 10 kHz. Move the counter input to the sync output of the HP 3325B. Set the counter to average 1000 periods. Electronic counter should indicate 100 000.00 ns ± 0.5 ns.
- f. Change the HP 3325B function to positive slope ramp. Electronic counter should indicate 100 000.00 ns ± 0.5 ns.

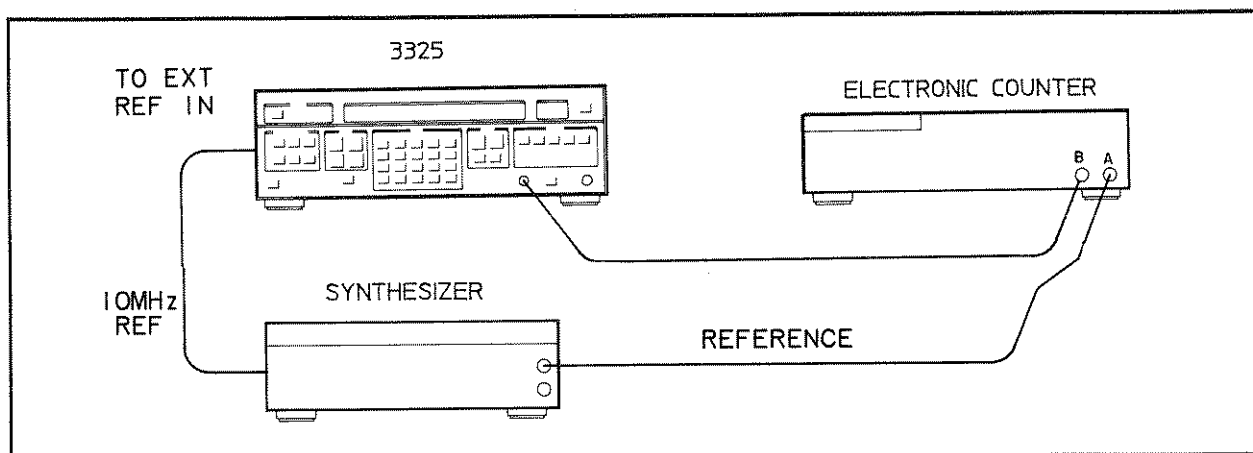

Figure 4-12. Phase Increment Accuracy.

Phase Increment Accuracy

This test compares the HP 3325B phase increment accuracy to the following specification:

$$\pm 0.2^\circ$$

Equipment Required: Frequency Synthesizer
Electronic Counter

- a. Connect the equipment as shown in figure 4-12.
- b. Set the HP 3325B as follows:

High Voltage Output (option 002)	Off
Function	Sine
Frequency	100 kHz
Amplitude	13 dBm
- c. Set the synthesizer as follows:

Frequency	0.1 MHz
Amplitude	13 dBm
- d. Set the counter as follows:

Function	Time Interval Avg A to B
Frequency Resolution, N	10^5
Inputs	50 Ω , Separate
Slope A and B	Positive
Sample Rate	Maximum
- e. Press the HP 3325B [Phase] key to display phase. Using the modify keys, adjust the phase until the counter reads approximately 200 ns. Press the blue [Shift] key, then the [Asgn Zero Φ] key.

- f. Set the counter sample rate to hold, then reset the counter. Record the counter reading (to 2 decimal places) on the Performance Test Record in the space for *Zero Phase Time Interval*. This is the phase difference (in nanoseconds) between the HP 3325B output and the reference signal.
- g. Set the HP 3325B phase to -1° .
- h. Reset the counter. Record the counter reading (to 2 decimal places) in the space for *1° Increment Time Interval*.
- i. Determine the time difference between the counter readings in steps h and f, and record in the *Time Difference* column. The difference should be from 22.22 to 33.34 ns.
- j. Set the HP 3325B phase to -10° .
- k. Reset the counter. Record the counter reading in the space for *10° Increment Time Interval*.
- l. Enter the time difference between the *Zero Phase Time Interval* and the reading in step k in the *Time Difference* column. This should be from 272.22 to 283.34 ns.
- m. Set the HP 3325B phase to -100° .
- n. Reset the counter. Record the counter reading in the space for *100° Incremental Time Interval*.
- o. Enter the time difference between the *Zero Phase Time Interval* and the reading in step n in the *Time Difference* column. It should be from 2722.22 to 2783.34 ns.

Phase Modulation Linearity

This procedure compares the HP 3325B phase modulation linearity to the following specification:

$\pm 0.5\%$, best fit straight line

Equipment Required: Frequency Synthesizer
Electronic Counter
DC Power Supply
Digital Voltmeter

- a. Connect the equipment as shown in figure 4-13.

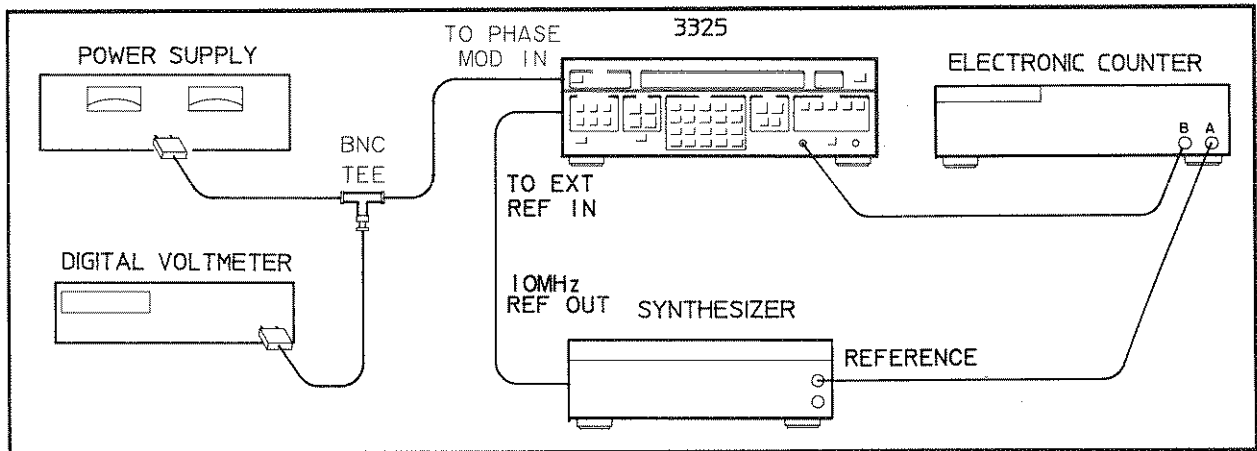

Figure 4-13. Phase Modulation Linearity.

- b. Set the HP 3325B as follows:

High Voltage Output (option 002)	Off
Function	Sine
Frequency	100 kHz
Amplitude	13 dBm
Phase Modulation	On
- c. Set the synthesizer as follows:

Frequency	100 kHz
Amplitude	13 dBm
- d. Set the electronic counter as follows:

Function	Time Interval Avg A to B
Frequency Resolution, N	10^5
Inputs	50Ω , Separate
Slope A and B	Positive
Sample Rate	Maximum
- e. Using the voltmeter to monitor the dc power supply output, set the dc voltage as near $-5.0000V$ as possible.
- f. Press the HP 3325B [Phase] key to display phase. Using the modify keys, adjust the phase until the counter reads approximately 200 ns. Record the counter reading as a reference for the following steps.
- g. As soon as possible after recording the counter reading, note the voltmeter reading and record on the Performance Test Record in the *DVM Reading*, x_1 space.
- h. Press the HP 3325B blue [Shift] key, then the [Asgn Zero Φ] key.
- i. Change the dc power supply output to $-4.0000V$.
- j. Using the modify keys, adjust the HP 3325B phase to return the counter reading to the value recorded in step f.

- k. Record the voltmeter reading in the *DVM Reading*, x_2 space.
- l. The HP 3325B display indicates the phase change resulting from the 1V change in modulating voltage. Record the phase display in the *Phase Difference*, 2 space (positive value).
- m. Press the HP 3325B blue [Shift] key, then the [Asgn Zero Φ] key.
- n. Change the power supply output to the following voltages and repeat steps j through m for each. Record the DVM reading and phase differences in the appropriate spaces on the Performance Test Record.

DC Voltage	DVM Reading	Phase Difference
-3.0000V	x_3	3
-2.0000V	x_4	4
-1.0000V	x_5	5
0.0000V	x_6	6
+1.0000V	x_7	7
+2.0000V	x_8	8
+3.0000V	x_9	9
+4.0000V	x_{10}	10
+5.0000V	x_{11}	11

- o. Enter the cumulative phase change in the *Cumulative Phase* column. That is, enter the 2 *Phase Difference* in the y_2 space, then add the y_2 and 3 values and enter in the y_3 space. Add the y_3 and 4 values and enter in y_4 , and so on.
- p. On the Performance Test Record, multiply each x value by the corresponding y value and enter in the x times y column.
- q. Total the *DVM Reading* column and enter in the Σx space. Total the *Cumulative Phase* values and enter in the Σy space. Total the x times y values and enter in the Σxy space.
- r. Square each x value and enter in the x^2 column. Total this column and enter in the Σx^2 space.
- s. Square the Σx value and enter in the $(\Sigma x)^2$ space.
- t. Multiply the Σx value by the Σy value and enter in the $\Sigma x \Sigma y$ space.
- u. The equation for determining the best fit line specification for each y value is:

$$y = a_1x + a_0$$

Where: a_1x and a_0 are constants to be calculated from data taken previously

Where: x is the value of the modulating voltage, recorded as x_1 through x_{11}

- v. First determine the value of a_1 using the following equation:

$$a_1 = \frac{\Sigma xy - \frac{\Sigma x \Sigma y}{n}}{\frac{\Sigma x^2 - \frac{(\Sigma x)^2}{n}}{n}}$$

Where: Σx , Σy , Σxy , $\Sigma x \Sigma y$, Σx^2 , and $(\Sigma x)^2$ are the previously calculated values entered on the Performance Test Record

Where: $n = 11$ (the number of points to be calculated)

- w. Determine the value of a_0 using the equation:

$$a_0 = \frac{\Sigma y}{n} - a_1 \frac{\Sigma x}{n}$$

- x. Calculate each value for y using the equation: $y = a_1x + a_0$. Enter each result on the Performance Test Record in the *Best Fit Straight Line Values* column, (y_1) through (y_{11}).
- y. Determine the test limits for each y value by increasing and decreasing the calculated (y) values by 0.5% of the (y_{11}) value. Enter in the Maximum and Minimum columns.
- z. Transfer the y_1 through y_{11} *Cumulative Phase* entries to the *Measured Cumulative Phase* column. Each value should be within the calculated limits.

Amplitude Accuracy

This procedure tests the amplitude accuracy of the HP 3325B ac function output signals to the specifications listed in Appendix A:

- Equipment Required:
- AC/DC Digital Voltmeter
 - AC: Accuracy sufficient to verify a 1% specification to 100 kHz
 - DC: Resolution, 1 μV
 - High Speed Digital DC Voltmeter
 - At least 3 1/2 digit resolution, 1 1/2 μs or faster settling time.
 - 50 Ω , 0-12 dB (1 dB/step) Attenuator
 - 50 Ω Feedthru Termination
 - Thermal Converter
 - Analog Oscilloscope
 - Must have delayed sweep of 0.05 $\mu\text{s}/\text{div}$ and delayed sweep gate output.
 - Components:
 - 2 Resistors 36.55 Ω 0.1% 0.125W
 - 2 Resistors 61.11 Ω 0.1% 0.25W
 - Resistor 43 Ω * 0.1% 0.125W
 - 3 Resistors 1330 Ω * 0.1% 0.25W
 - Capacitor 300 pF * 5%

**Used only to test High Voltage (option 002)*

Amplitude Accuracy at Frequencies up to 100 kHz

- a. Sine Wave Test. Connect the HP 3325B signal output through a 50 Ω feedthru termination to the ac digital voltmeter input.
- b. Set the HP 3325B as follows:

High Voltage Output (option 002)	Off
Function	Sine
Frequency	100 Hz
Amplitude	3.536 Vrms (10 V _{pp})
DC Offset	0V
- c. Press the [Amptd Cal] key.
- d. Read ac voltmeter. Change the HP 3325B frequency to 1 kHz and 100 kHz and repeat. Verify that all three voltmeter reading are between 3.495 and 3.577 Vrms (± 0.1 dB).
- e. Change the HP 3325B amplitude to 1.061 Vrms (3 V_{pp}) and take ac voltage readings for 100 Hz, 1 kHz and 100 kHz as above. Verify that all three voltmeter readings are between 1.048 and 1.073 Vrms (± 0.1 dB).
- f. Change the HP 3325B amplitude to 0.3536 Vrms and set dc offset to 1 mV. Set the HP 3325B frequency to 100 Hz, 1 kHz and 100 kHz and read ac voltage. Verify that all three readings are between 0.3411 and 0.3660 Vrms (± 0.3 dB).

- g. Function Test. Connect the HP 3325B sync output to external trigger input of oscilloscope. Connect the HP 3325B signal output to the voltage divider of figure 4-14A. Connect the voltage divider output to oscilloscope vertical input and to high speed voltmeter input. Connect delayed sweep gate from oscilloscope to external trigger input of high speed voltmeter (see figure 4-14A).
- h. Set the HP 3325B as follows:
- | | |
|----------------------------------|--------------------|
| High Voltage Output (option 002) | Off |
| DC Offset | 0V |
| Amplitude | 10 V _{pp} |
| Frequency | 99.9 Hz |
| Function | Square |
- i. Set the oscilloscope as follows:
- | | |
|----------------------|---------------|
| Display | A or B |
| Vertical Sensitivity | 0.5 V/div |
| Trigger | Ext |
| Main Sweep | 1 ms/div |
| Delayed Sweep | 5 μ s/div |
| Delay | 250 |
- j. Set the voltmeter as follows:
- | | |
|----------|------------------|
| Range | 1.0V |
| Trigger | Ext |
| Delay | 0s |
| Coupling | DC, 1 M Ω |
- k. One cycle of the square wave should fill the screen of the oscilloscope, and the sample time for the voltmeter should be seen as the intensified spot of the delayed sweep.
- l. Press [Amptd Cal] on the HP 3325B.
- m. Read positive peak voltage of attenuated waveform on voltmeter. If the reading is not stable, alternately press hold, then ext to repeat readings. Change oscilloscope delay to 750 and read negative peak. Add the two readings to obtain volts peak-to-peak. Verify that sum is between 3.661 and 3.735 V.
- n. Change the HP 3325B function to triangle. Change oscilloscope to:
- | | |
|----------------------|---------------|
| Vertical Sensitivity | 0.2 V/div |
| Vertical Position | 9 o'clock |
| Main Sweep | 0.5 ms/div |
| Delay | 500 |
| Magnify | X10 |
| Delayed Sweep | 1 μ s/div |
- o. Adjust oscilloscope delay to place the intensified spot on peak of triangle and read positive peak voltage on the high speed digital voltmeter. Press negative trigger, move vertical position knob of oscilloscope to 3 o'clock and adjust intensified spot to read negative peak on the voltmeter. Verify that sum of positive and negative peak voltage is between 3.643 and 3.754 V.

- p. Change the HP 3325B function to positive ramp. Change oscilloscope to:

Trigger	positive
Main Sweep	2 ms/div

Place intensified spot on positive peak. Alternately press hold, then ext to repeat readings. Record the most positive reading.

- q. Move vertical position knob to 3 o'clock, adjust delay and read negative peak. Ramp jitter should be visible on all ramp readings (the high speed digital voltmeter will hold the readings). Verify that sum of positive and negative peaks is between 3.643 and 3.754 V.
- r. Change the HP 3325B function to negative ramp. Change oscilloscope trigger to positive and take negative ramp reading as above.
- s. Change the HP 3325B function to square and frequency to 1 kHz. Set oscilloscope as follows:

Main Sweep	50 μ s/div
Delayed Sweep	0.05 μ s/div

Read positive peak; push negative trigger and read negative peak. Verify that sum is between 3.661 and 3.735 V.

- t. Change the HP 3325B function to triangle and frequency to 2 kHz. Set oscilloscope main sweep to 20 μ s/div and delay to 610. Adjust delay and position. Set positive and negative trigger to read peaks. Verify voltage to be between 3.643 and 3.754 V_{pp} .
- u. Change the HP 3325B function to positive ramp and frequency to 500 Hz. Set main sweep of oscilloscope to 0.2 ms/div and adjust sweep vernier to return peaks to center screen (trigger must be negative to see jitter at this point). Verify voltage to be between 3.643 and 3.754 V_{pp} .
- v. Change the HP 3325B function to negative ramp and oscilloscope trigger to positive. Verify voltage of 3.643 to 3.754 V_{pp} .
- w. Change HP 3325B frequency to 100 kHz and function to square. Return oscilloscope sweep vernier to calibrate and set main sweep to 0.5 μ s/div and magnify to off. Read positive and negative peak voltages in the center of the screen. By pressing positive/negative trigger, verify voltage of 3.661 to 3.735 V_{pp} .
- x. Change the HP 3325B function to triangle (frequency will go to 10 kHz). Set oscilloscope main sweep to 5 μ s/div and press magnify. Verify voltage of 3.513 to 3.883 V_{pp} .
- y. Change the HP 3325B function to positive ramp. Set oscilloscope main sweep to 20 μ s/div. Adjust delay to set end of intensified spot on highest peak. Verify voltage of 3.328 to 3.996 V_{pp} .
- z. Change the HP 3325B function to negative ramp. Verify voltage of 3.328 to 3.996 V_{pp} .

- aa. Change the HP 3325B amplitude to $3 V_{pp}$, and remove the voltage divider from the circuit. Reconnect the HP 3325B signal output to the oscilloscope and voltmeter through the 50Ω feedthru termination. Set the HP 3325B frequency to 99.9 Hz and the function to square.
- bb. Repeat tests i through z. Test limits are as follows:

Test	Frequency	Function	Minimum	Maximum
m	99.9 Hz	Square	2.970V	3.030V
o	99.9 Hz	Triangle	2.955V	3.045V
q	99.9 Hz	+ Ramp	2.955V	3.045V
r	99.9 Hz	- Ramp	2.955V	3.045V
s	1 kHz	Square	2.970V	3.030V
t	2 kHz	Triangle	2.955V	3.045V
u	500 Hz	+ Ramp	2.955V	3.045V
v	500 Hz	- Ramp	2.955V	3.045V
w	100 kHz	Square	2.970V	3.030V
x	10 kHz	Triangle	2.850V	3.150V
y	10 kHz	+ Ramp	2.700V	3.300V
z	10 kHz	- Ramp	2.700V	3.300V

- cc. Change the HP 3325B amplitude to $1 V_{pp}$, and set dc offset to 1 mV. Set frequency to 99.9 Hz and function to square. Set oscilloscope vertical sensitivity to 0.05 V/div for all $1 V_{pp}$ tests.
- dd. Repeat tests i through z. Test limits are as follows:

Test	Frequency	Function	Minimum	Maximum
m	99.9 Hz	Square	0.970V	1.030V
o	99.9 Hz	Triangle	0.960V	1.040V
q	99.9 Hz	+ Ramp	0.960V	1.040V
r	99.9 Hz	- Ramp	0.960V	1.040V
s	1 kHz	Square	0.970V	1.030V
t	2 kHz	Triangle	0.960V	1.040V
u	500 Hz	+ Ramp	0.960V	1.040V
v	500 Hz	- Ramp	0.960V	1.040V
w	100 kHz	Square	0.970V	1.030V
x	10 kHz	Triangle	0.940V	1.060V
y	10 kHz	+ Ramp	0.890V	1.110V
z	10 kHz	- Ramp	0.890V	1.110V

**High Voltage Output Amplitude Accuracy for Frequencies to 100 kHz
(for instruments with high voltage option 002)**

- ee. Sine Wave Test. Connect the HP 3325B signal output to the ac voltmeter with a 6 foot cable. Connect a 500Ω , 300 pF load (at either end) in parallel with the line.
- ff. Select the high voltage output on the HP 3325B. A LED near the key indicates that the high voltage output is on.

- gg. Set the HP 3325B function to sine, frequency to 2 kHz, and amplitude to 14.14 V_{rms} (40 V_{pp}). Press [Amptd Cal]. The ac voltmeter reading should be 13.86 to 14.42 V_{rms}.
- hh. High Voltage Function Test. Connect the HP 3325B signal output to oscilloscope and voltage divider with a 6 foot cable. Trigger oscilloscope on HP 3325B sync output. Trigger high speed voltmeter on delayed sweep gate from oscilloscope (see figure 4-14B).
- ii. The voltage divider shown in figure 4-14B is built into a small metal box with 2 BNC connectors. Parts used are:

R3, 443Ω consists of 3 parallel 1330Ω resistors, each 0.1%, 0.25W
 R4, 43Ω, 0.1%, 0.125W
 C1, 300 pF, 5%

Connect the tap to the input of high speed voltmeter as shown in figure 4-14B.

- jj. Set the HP 3325B frequency to 2 kHz and amplitude to 40 V_{pp}. Set voltmeter to 1V range and external trigger. Set oscilloscope as follows:

Vertical Sensitivity	2 V/div
Vertical Position	8 o'clock
Trigger	External
Main Sweep	20 μs/div
Delayed Sweep	0.05 μs/div
Delay	615
Magnify	× 10

- kk. Set the HP 3325B to square wave and read positive peak on voltmeter. Switch oscilloscope to negative trigger, vertical position to 4 o'clock, and read negative peak. Verify that voltage is between 3.466 and 3.607 V_{pp}.
- ll. Change the HP 3325B function to triangle, and read peak voltages. Voltage should be 3.466 to 3.607 V_{pp}.
- mm. Change the HP 3325B to positive ramp. Change oscilloscope main sweep to 0.1 ms/div and delay to 500. Verify voltage of 3.466 to 3.607 V_{pp}. Repeat for negative ramp by changing oscilloscope trigger to positive.

Amplitude Flatness: (Frequencies above 100 kHz)

- nn. Set the HP 3325B as follows:

High Voltage Output (option 002)	Off
Function	Sine
Frequency	1 kHz
Amplitude	3 V _{pp}

- oo. Set the 50Ω attenuator to 3 dB and connect to signal output. Connect 1 V_{rms} thermal converter to attenuator output. Connect voltmeter with microvolt resolution to thermal converter output (see figure 4-14C).
- pp. Press the HP 3325B [Amptd Cal] key. Record the voltmeter reading in the 3V sine wave 1 kHz reference space on the Performance Test Record.

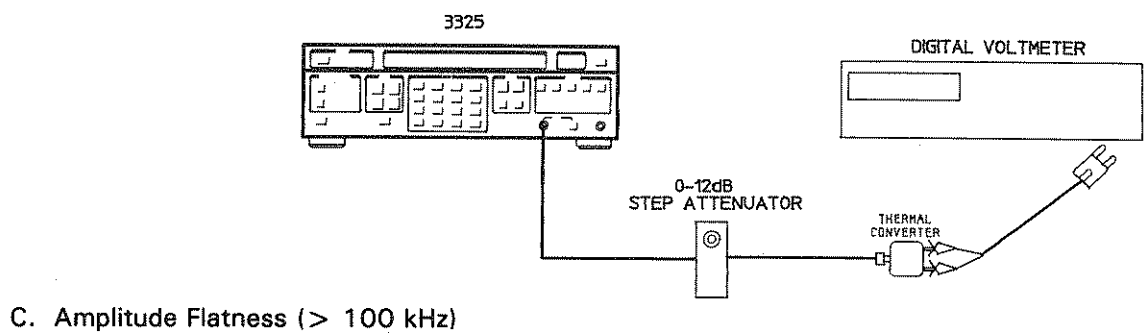
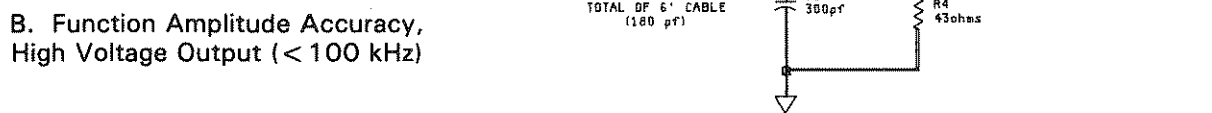
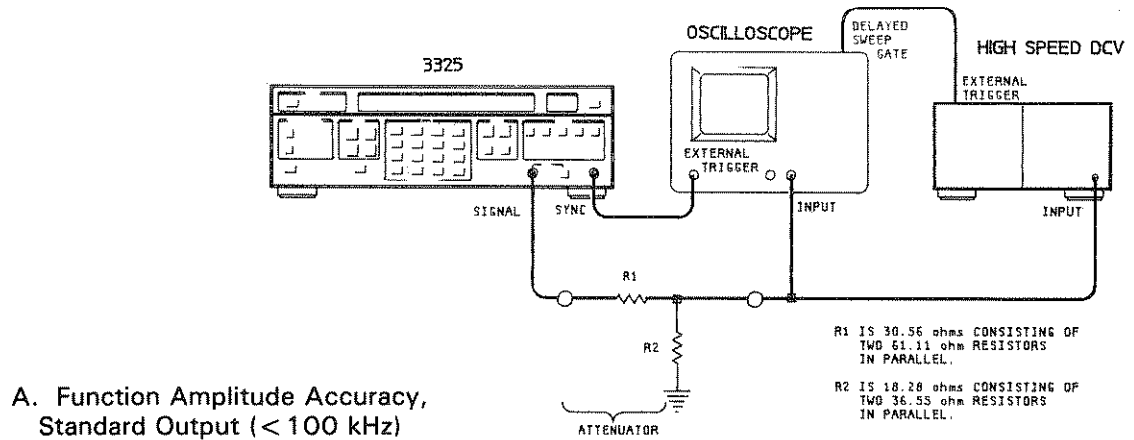

Figure 4-14. Amplitude Accuracy and Flatness.

Performance Tests

- qq. Use the modify keys to increase the frequency in 2 MHz steps from 1 kHz to 20.001 MHz, recording the voltmeter reading at each frequency. In each case, allow the thermal converter several seconds to stabilize.
- rr. Verify that all flatness readings are within $\pm 6.6\%$ of the 1 kHz reference reading.
- ss. Change attenuator to 12 dB. Change the HP 3325B amplitude to 10 V_{pp}. Repeat steps pp and qq for 10 V_{pp}. Verify that all readings are within 6.3% of the 1 kHz reference.

tt. Disconnect the thermal converter from the HP 3325B output.

uu. Square wave flatness. Set the HP 3325B as follows:

High Voltage Output (option 002)	Off
Function	Square
Frequency	1 kHz
Amplitude	10 V _{pp}

vv. Connect the HP 3325B signal output to an oscilloscope with a 50Ω feedthru termination. Set the oscilloscope as follows:

Vertical Sensitivity	2 V/div
Time/Div	0.1 ms

ww. Use the modify keys to increase the HP 3325B frequency from 1 kHz to 10.001 MHz in 2 MHz steps. Two lines will appear on the oscilloscope. Verify that they remain within 1/2 major division of 5 divisions apart for all 11 frequencies.

High Voltage Output (option 002) Amplitude Flatness above 100 kHz

xx. Connect the HP 3325B output to an oscilloscope with a 500Ω, 500 pF load (load attached at either end). Cable capacitance (30 pF/foot) must be included in the 500 pF. The HV divider (figure 4-14B) may be used with 6 feet of cable.

yy. Set the oscilloscope as follows:

Vertical Sensitivity	10 V/div
Time/Div	1 ms

zz. Set the HP 3325B to 40 V_{pp} sine wave and 1 kHz. Adjust oscilloscope intensity and focus for a sharp trace.

aaa. Use the modify keys to increase the HP 3325B frequency from 1 kHz to 1.001 MHz in 200 kHz steps. Verify that the width of the bright region of the screen is 4 ± 0.4 divisions for all 11 frequencies.

DC Offset Accuracy (DC Only)

This procedure tests the HP 3325B dc offset accuracy when no ac function output is present to the following specifications:

$\pm 0.4\%$ of full range*

* Except lowest attenuator range where accuracy is $\pm 20 \mu\text{V}$

Equipment Required: DC Digital Voltmeter with 5 digit resolution, capable of measuring > 20V for high voltage output (option 002)
50 Ω Feedthru Termination

- a. Connect the HP 3325B signal output directly to the 50 Ω feedthru termination and then with a cable to the dc digital voltmeter input (see figure 4-15A).
- b. Press whichever function key is presently active, indicated by a lighted indicator beside the key. This removes the ac output. The indicator beside the [DC Offset] key should light.
- c. Set the HP 3325B dc offset to 5V, then press [Amptd Cal].
- d. The voltmeter reading should be +4.980 to +5.020 V.
- e. Change the HP 3325B dc offset to -5V. Voltmeter reading should be -4.980 to -5.020 V.

Attenuator Test

- f. Set the dc offset to the positive and negative voltages shown below. The digital voltmeter reading should be within the tolerances shown for each voltage.

DC Offset	Tolerances
$\pm 1.499\text{V}$	± 1.49300 to 1.50499 V
$\pm 499.9\text{ mV}$	± 0.49790 to 0.50190 V
$\pm 149.9\text{ mV}$	± 0.14930 to 0.15050 V
$\pm 49.99\text{ mV}$	± 0.04979 to 0.05019 V
$\pm 14.99\text{ mV}$	± 0.01493 to 0.01505 V
$\pm 4.999\text{ mV}$	± 0.004979 to 0.005019 V
$\pm 1.499\text{ mV}$	± 0.001479 to 0.001519 V

High Voltage Output (option 002) DC Offset

- g. Remove the 50 Ω feedthru termination and connect the HP 3325B output directly to the voltmeter input.
- h. Select the high voltage output on the HP 3325B. A LED near the key indicates that the high voltage output is on.
- i. Set the HP 3325B dc offset to 20V. Voltmeter reading should be +19.775 to 20.225 V.

- j. Set the HP 3325B dc offset to -20V . Voltmeter reading should be -19.775 to -20.225 V

DC Offset Accuracy with AC Functions

This procedure compares the HP 3325B dc offset with ac functions accuracy to the following specifications:

- DC + AC, $\leq 1\text{ MHz}$: $\pm 1.2\%$, Ramps $\pm 2.4\%$
- DC + AC, $> 1\text{ MHz}$: $\pm 3\%$

Equipment Required: DC Digital Voltmeter
50 Ω Feedthru Termination

- a. Connect the equipment as shown in figure 4-15A. Set the voltmeter to measure dc voltage.
- b. Set the HP 3325B output as follows:

High Voltage Output (option 002)	Off
Function	Sine
Frequency	20.999 999 999 MHz
Amplitude	1 V _{pp}
DC Offset	+4.5V
- c. Press [Amptd Cal]. After amplitude calibration (approximately 2 seconds) the voltmeter reading should be $+4.350$ to $+4.650\text{ Vdc}$.
- d. Change the dc offset to -4.5V . Voltmeter reading should be -4.350 to -4.650 Vdc .
- e. Change the HP 3325B frequency to 999.9 kHz . The voltmeter reading should be -4.440 to -4.560 Vdc .
- f. Change the HP 3325B dc offset to $+4.5\text{V}$. The voltmeter reading should be $+4.440$ to $+4.560\text{ Vdc}$.
- g. Set the HP 3325B function to square. The voltmeter reading should be $+4.440$ to $+4.560\text{ Vdc}$.
- h. Change the HP 3325B dc offset to -4.5V . The voltmeter reading should be -4.440 to -4.560 Vdc .
- i. Change the HP 3325B frequency to 9.9999 MHz . The voltmeter reading should be -4.350 to -4.650 V .
- j. Set the HP 3325B function to triangle, frequency to 9.9 kHz . The voltmeter reading should be -4.440 to -4.560 V .
- k. Set the function to positive ramp. The voltmeter reading should be -4.380 to -4.620 V .

Triangle Linearity

This procedure tests the linearity of the HP 3325B triangle wave output to the following specifications:

$\pm 0.05\%$ of full output, 10% to 90%, best fit straight line

Because the triangle and ramp outputs are generated by the same circuits, this procedure effectively tests the ramp linearity also.

Equipment Required: High-Speed DC Digital Voltmeter (This procedure is written to use the high speed and delay capabilities of the HP 3437A)
Resistive Divider, ± 2.5 , consisting of:
30 Ω $\pm 1\%$ 1/4W
20 Ω $\pm 1\%$ 1/4W
BNC-to-Triax Adapter

- a. Connect the HP 3325B and the high-speed voltmeter through the divider as shown in figure 4-15B.

- b. Set the HP 3325B as follows:

High Voltage Output (option 002)	Off
Function	Triangle
Frequency	10 kHz
Amplitude	10 V _{pp}

- c. Set the voltmeter as follows:

Range	1V
Number of Readings	1
Trigger	External

NOTE The HP 3437A triggers on the negative going edge of the HP 3325B sync square wave.

- d. Set the voltmeter delay to 0.00003 (seconds). Record the voltmeter reading on the Performance Test Record under *Positive Slope Measurement, (10%) y1*. This is the 10% point on the positive slope of the triangle (see figure 4-15C).
- e. Measure the voltage at each 10% segment point by setting the voltmeter delay to the following. Enter on the Performance Test Record in the appropriate spaces under *Positive Slope Measurement*.

Delay	Percent of Slope
0.000035	20
0.00004	30
0.000045	40
0.00005	50
0.000055	60
0.00006	70
0.000065	80
0.00007	90

- f. Measure the voltage at each 10% segment point on the negative slope by setting the voltmeter delay to the following. Enter the reading on the Performance Test Record in the appropriate spaces under *Negative Slope Measurement*.

Delay	Percent of Slope
0.00008	90
0.000085	80
0.00009	70
0.000095	60
0.0001	50
0.000105	40
0.00011	30
0.000115	20
0.00012	10

- g. Algebraically add the voltages recorded in the *Positive Slope Measurement* column and enter the total in the Σy space.
- h. Multiply Σy by 45 (which is Σx) and enter the result in the $\Sigma x \Sigma y$ space.
- i. Multiply each y value by the corresponding x value and enter in the x times y column. Total these values and enter in the Σxy space.
- j. The equation for determining the best fit straight line specification for each y value is:

$$y = a_1x + a_0$$

Where: a_1 and a_0 are constants to be calculated from data taken previously.

NOTE Calculate the values of a_1 and a_0 to at least five decimal places.

- k. First determine the value of a_1 using the following equation:

$$a_1 = \frac{\Sigma xy - \frac{\Sigma x \Sigma y}{n}}{\Sigma x^2 - \frac{(\Sigma x)^2}{n}}$$

Where: Σx , Σy , Σxy , $\Sigma x \Sigma y$, Σx^2 , and $(\Sigma x)^2$ are the previously calculated values entered on the Performance Test Record.

Where: $n = 9$ (the number of points to be calculated)

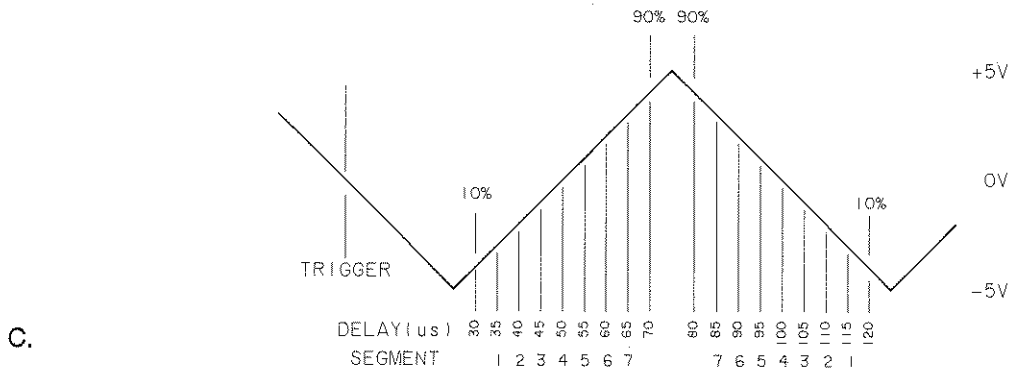
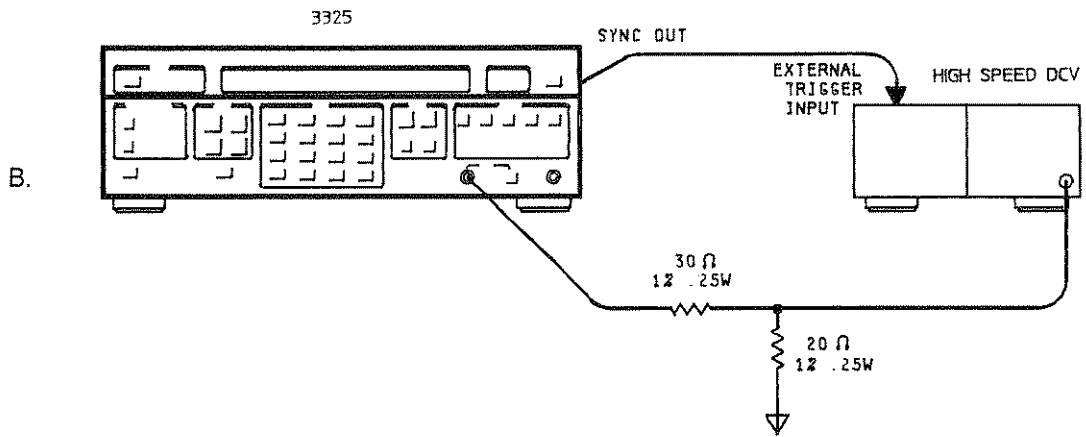
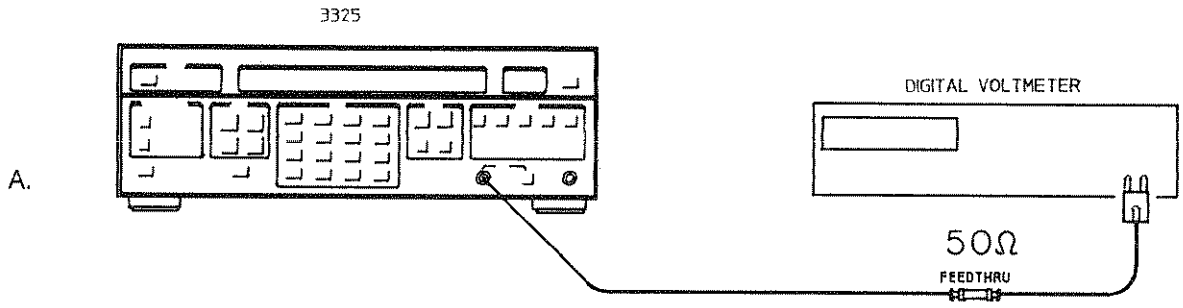

Figure 4-15. Triangle Linearity.

Performance Tests

- l. Determine the value of a_0 using the equation:

$$a_0 = \frac{\sum y}{n} - a_1 \frac{\sum x}{n}$$

- m. Calculate the best fit straight line value for each point (y_1 through y_9) using the equation:

$$y = a_1x + a_0$$

Enter each result on the Performance Test Record in the *Best Fit Straight Line* column.

- n. For each delay (x), subtract the calculated voltage (y') from the measured voltage (y). Find the largest positive voltage difference ($+V_{\max}$) and the largest negative difference ($-V_{\max}$). Using the following formula, compute the % linearity.

$$\% \text{ LINEARITY} = \frac{|+V_{\max}| + |-V_{\max}|}{8 \text{ Volts}} \times 100\%$$

- o. Algebraically add the voltages recorded in the *Negative Slope Measurement* column and enter the total in the $\sum y$ space.
- p. Repeat steps h through n to determine the best fit straight line values and tolerances for the negative slope. The voltages measured and recorded in the *Negative Slope Measurement* column should be within the calculated tolerances.

X Drive Linearity

This procedure tests the linearity of the HP 3325B rear panel X Drive output to the following specifications: for all linear sweep widths which are integral multiples of the minimum sweep width for each function and sweep time:

$\pm 0.1\%$ of final value, 10% to 90%, best fit straight line.

Equipment Required: High-Speed DC Digital Voltmeter (This procedure is written to use the high speed and delay capabilities of the HP 3437A)
Resistive Divider, $\div \sim 2.6$, consisting of:
100 k Ω 1% 1/8W
162 k Ω 1% 1/8W
DC Power Supply
BNC-to-Triax Adapter

- a. Connect the equipment as shown in figure 4-16A.

- b. Set the HP 3325B as follows:
- | | |
|----------------------------------|--------------------|
| High Voltage Output (option 002) | Off |
| Function | Sine |
| Amplitude | 10 V _{pp} |
| Sweep Start Frequency | 1 MHz |
| Sweep Stop Frequency | 10 MHz |
| Sweep Marker Frequency | 4 MHz |
| Sweep Time | 0.01s |
- c. Press the HP 3325B [Start Cont] key.
- d. Set the voltmeter as follows:

Range	1V
Number of Readings	1
Trigger	External

NOTE The HP 3437A triggers on the negative going edge of the Z Blank signal, which occurs at the start of a sweep up.

- e. Set the voltmeter delay to 0.001 (seconds). Adjust the dc power supply for a voltmeter reading of -1.600V. Record the voltmeter reading on the Performance Test Record under *X Drive Ramp Measurement, (10%), y₁*. This is the 10% point on the X Drive ramp (see figure 4-16B).
- f. Measure the voltage at each 10% segment point by setting the voltmeter delay to the following. Enter on the Performance Test Record in the appropriate spaces under *X Drive Ramp Measurement*.

Delay	Percent of Ramp
0.002	20
0.003	30
0.004	40
0.005	50
0.006	60
0.007	70
0.008	80
0.009	90

- g. Algebraically add the voltages recorded in the *X Drive Ramp Measurement* column and enter the total in the Σy space.
- h. Multiply Σy by 45 (which is Σx) and enter the result in the $\Sigma x \Sigma y$ space.
- i. Multiply each *y* value by the corresponding *x* value and enter in the *x times y* column. Total these values and enter in the Σxy space.
- j. The equation for determining the best fit straight line specification for each *y* value is:

$$y = a_1x + a_0$$

Where: a_1 and a_0 are constants to be calculated from data taken previously.

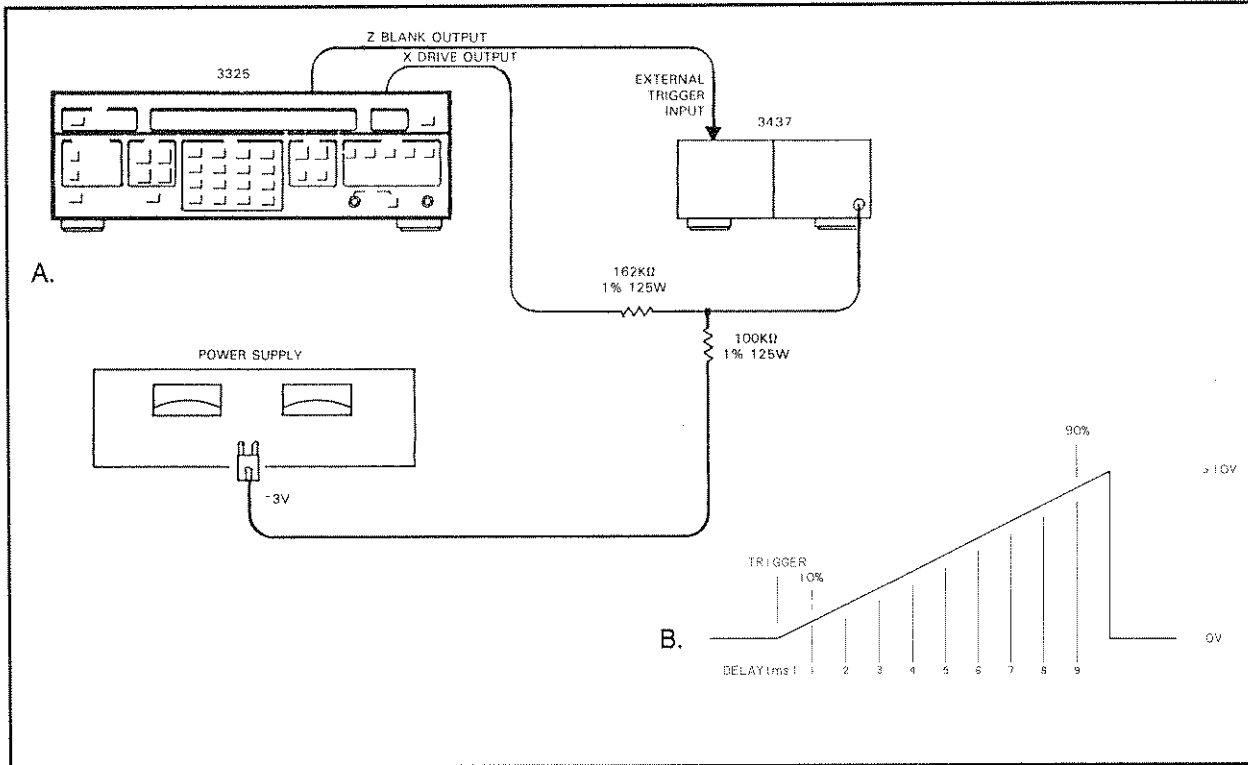

Figure 4-16. X Drive Linearity

NOTE Calculate the values of a_1 and a_0 to at least five decimal places.

k. First determine the value of a_1 using the following equation:

$$a_1 = \frac{\sum xy - \frac{\sum x \sum y}{n}}{\frac{\sum x^2 - (\sum x)^2}{n}}$$

Where: $\sum x$, $\sum y$, $\sum xy$, $\sum x \sum y$, $\sum x^2$, and $(\sum x)^2$ are the previously calculated values entered on the Performance Test Record.

Where: $n = 9$ (the number of points to be calculated)

l. Determine the value of a_0 using the equation:

$$a_0 = \frac{\sum y}{n} - a_1 \frac{\sum x}{n}$$

- m. Calculate the best fit straight line value for each point (y_1 through y_9) using the equation:

$$y = a_1x + a_0$$

Enter each result on the Performance Test Record in the *Best Fit Straight Line* column.

- n. Determine the minimum and maximum allowable voltages at each point by subtracting and adding 0.004V to the voltage calculated in step m ($10.5V \pm 2.6 \times 0.1\%$). Enter these voltage limits on the Performance Test Record under *Minimum* and *Maximum*. The voltage measured and recorded in the *X Drive Ramp Measurement* column should be within these calculated tolerances.

NOTE The HP 3325B X Drive maximum voltage (100%) is set at the factory to +10.5V.

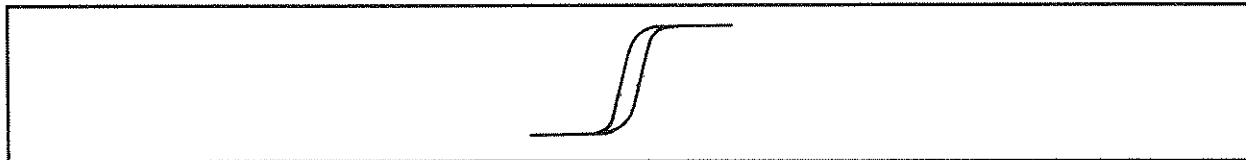

Figure 4-17. Ramp Period Variation.

Ramp Period Variation

This procedure tests the variation between alternate cycles of the HP 3325B positive and negative slope ramps to the following specification:

< ±1% of period, maximum

Equipment Required: Analog Oscilloscope, with delayed sweep

- a. Connect the HP 3325B signal output to the oscilloscope vertical input. (Do NOT use a 10:1 probe.) Set the input switch to the 50Ω position. If your oscilloscope does not have a 50Ω input, use a 50Ω feedthru termination at the input.

- b. Set the HP 3325B as follows:

Function	Negative Slope Ramp
Frequency	100 Hz
Amplitude	10 V _{pp}

- c. Set the oscilloscope as follows:

Vertical	2 V/div
Main sweep	2.0 ms/div
Delayed sweep	20 μs/div
Trigger	Positive

- d. With the oscilloscope horizontal controls set to main sweep, adjust the intensified portion of the trace to the reset (positive going) portion of the ramp.
- e. Set the horizontal controls to delayed sweep and position the ramp reset portion near the center of the display.
- f. The reset portion should show more than one line, as in figure 4-17. The lines should not be separated by more than ten divisions on the display.
- g. Change the HP 3325B function to positive slope ramp and set oscilloscope trigger to negative to verify the positive ramp.
- h. Increase the HP 3325B frequency to 99.999999 Hz to check the low frequency ramps. Verify that ramp period variations do not exceed ten divisions.

OPERATIONAL VERIFICATION RECORD

Hewlett-Packard
Model 3325B
Synthesizer/Function Generator
Serial No. _____

Tested by _____

Date _____

Self Test Passed _____

Sine Wave Verification

Step d 20 MHz: Frequency and Amplitude Passed _____
Step g Signal Purity Passed _____
High Voltage Output (1 MHz) Passed _____

Square Wave Verification

Step c Frequency and Amplitude Passed _____
Steps d & e Aberrations Passed _____
Step f Rise Time Passed _____

Triangle and Ramp Verification

Step c Triangle Freq. and Amptd. Passed _____
Step d + Ramp Freq. and Amptd. Passed _____
Step e - Ramp Freq. and Amptd. Passed _____
Step f - Ramp Retrace Time Passed _____
Step g + Ramp Retrace Time Passed _____
Step i Triangle Linearity Passed _____

Amplitude Flatness Passed _____

Spec

Sync Output Check High _____ > +1.2 V
Low _____ < 0.2 V

Frequency Accuracy

Spec.

Step c Sine, 20 MHz _____ ± 100 Hz
Step d Square, 10 MHz _____ ± 50 Hz
Step e Triangle, 10 kHz (100,000 ns) _____ ± .5 ns
Step f Ramp, 10 kHz (100,000 ns) _____ ± .5 ns

Fall Time _____ < 20 ns
 Overshoot, Positive Peak _____ < 500 mV
 Overshoot, Negative Peak _____ < 500 mV

Ramp Retrace Time
 + Ramp _____ < 3 μ s
 - Ramp _____ < 3 μ s

Sync Output
 V_{high} _____ > +1.2 V
 V_{low} _____ < +0.2 V

Square Wave Symmetry _____ < 3.2 ns

Frequency Accuracy
 Sine, 20 MHz _____ \pm 100 Hz
 Square, 10 MHz _____ \pm 50 Hz
 Triangle, 10 kHz (100,000 ns) _____ \pm .5 ns
 Ramp, 10 kHz (100,000 ns) _____ \pm .5 ns

Phase Increment Accuracy

	Minimum	Time Difference	Maximum
Zero Phase Time Interval _____			
1° Increment Time Interval _____	22.22 ns	_____	33.34 ns
10° Increment Time Interval _____	272.22 ns	_____	283.34 ns
100° Increment Time Interval _____	2772.22 ns	_____	2783.34 ns

Phase Modulation Linearity

DVM Reading	Phase Difference	Cumulative Phase	x times y	x^2
x_1 _____	1 0 _____	y_1 0 _____	0 _____	_____
x_2 _____	2 _____	y_2 _____	_____	_____
x_3 _____	3 _____	y_3 _____	_____	_____
x_4 _____	4 _____	y_4 _____	_____	_____
x_5 _____	5 _____	y_5 _____	_____	_____
x_6 _____	6 _____	y_6 _____	_____	_____
x_7 _____	7 _____	y_7 _____	_____	_____
x_8 _____	8 _____	y_8 _____	_____	_____
x_9 _____	9 _____	y_9 _____	_____	_____
x_{10} _____	10 _____	y_{10} _____	_____	_____
x_{11} _____	11 _____	y_{11} _____	_____	_____
Σx _____		Σy _____	Σxy _____	Σx^2 _____
$(\Sigma x)^2$ _____		$\Sigma x \Sigma y$ _____		

PERFORMANCE TEST RECORD

Hewlett-Packard
 Model 3325B
 Synthesizer/Function Generator
 Serial No. _____

Tested By _____

Date _____

Harmonic Distortion

Fundamental Frequency	Specification
20 MHz	_____ - 25 dB
15 MHz	_____ - 30 dB
2 MHz	_____ - 40 dB
200 kHz	_____ - 60 dB
50 kHz	_____ - 65 dB
10 kHz	_____ - 65 dB
1 kHz	_____ - 65 dB
100 Hz	_____ - 65 dB

High Voltage Output (Option 002)

100 Hz	_____ - 65 dB
10 kHz	_____ - 65 dB
200 kHz	_____ - 60 dB
1 MHz	_____ - 40 dB

Spurious Signal

Mixer Spurious (2:1 spur/3:2 spur) _____ - 70 dB

	2:1 spur	3:2 spur	
4.100MHz	_____	_____	- 70dB
6.100MHz	_____	_____	- 70dB
8.100MHz	_____	_____	- 70dB
10.100MHz	_____	_____	- 70dB
12.100MHz	_____	_____	- 70dB
14.100MHz	_____	_____	- 70dB
16.100MHz	_____	_____	- 70dB
18.100MHz	_____	_____	- 70dB
20.100MHz	_____	_____	- 70dB

Close-in Spurious

5.0001MHz	_____ - 70dB
5.00001MHz	_____ - 70dB
5.000001MHz	_____ - 70dB
20.001MHz	_____ - 70dB
	_____ - 70dB
	_____ - 70dB
	_____ - 70dB

Integrated Phase Noise

19.901 MHz _____ - 60 dB

Amplitude Modulation Envelope Distortion

_____ - 30 dB

Square Wave Rise Time and Aberrations

Rise Time _____ < 20 ns

Operational Verification

Output Level and Attenuator Check

(DC Offset Only)

Entry	Min.	Max.
-5 V	-4.980 V _____	-5.020 V
(+)5 V	+4.980 V _____	+5.020 V
* (±) 1.499V	(±) 1.49300V _____	(±) 1.50499V
499.9 mV	+0.49790 V _____	+0.50190 V
149.9 mV	+0.14930 V _____	+0.15050 V
49.99 mV	+0.04979 V _____	+0.05019 V
14.99 mV	+0.01493 V _____	+0.01505 V
4.999 mV	+0.04979 V _____	+0.005019 V
1.499 mV	+0.001479 V _____	+0.001519 V

* All entries and limits are ±

High Voltage Output (Option 002)

20 V	+19.775 V _____	+20.225 V
-20 V	-19.775 V _____	-20.225 V

Harmonic Distortion

All Harmonics Below:

20 MHz	_____	-25 dB
15 MHz	_____	-30 dB
2 MHz	_____	-40 dB
200 kHz	_____	-60 dB
50 kHz	_____	-65 dB
10 kHz	_____	-65 dB
1 kHz	_____	-65 dB
100 Hz	_____	-65 dB

High Voltage Output (Option 002)

100 Hz	_____	-65 dB
10 kHz	_____	-65 dB
200 kHz	_____	-60 dB
1 MHz	_____	-40 dB

Close-In Spurious Signal Test

Passed _____

Best Fit Straight Line Phase	Minimum Limit	Measured Cumulative Phase	Maximum Limit
(y ₁) _____	_____	Y ₁ 0 _____	_____
(y ₂) _____	_____	Y ₂ _____	_____
(y ₃) _____	_____	Y ₃ _____	_____
(y ₄) _____	_____	Y ₄ _____	_____
(y ₅) _____	_____	Y ₅ _____	_____
(y ₆) _____	_____	Y ₆ _____	_____
(y ₇) _____	_____	Y ₇ _____	_____
(y ₈) _____	_____	Y ₈ _____	_____
(y ₉) _____	_____	Y ₉ _____	_____
(y ₁₀) _____	_____	Y ₁₀ _____	_____
(y ₁₁) _____	_____	Y ₁₁ _____	_____

Specification: $\pm 0.5\%$ of (y₁₁) = \pm _____ °

Amplitude Accuracy

Entry	Minimum	Measured	Maximum
Sine Wave Test			
Amplitude: 3.536 Vrms			
Sine, 100 Hz	3.495 V	_____	3.577 V
Sine, 1 kHz	3.495 V	_____	3.577 V
Sine, 100 kHz	3.495 V	_____	3.577 V
Amplitude: 1.061 Vrms			
Sine, 100 Hz	1.048 V	_____	1.073 V
Sine, 1 kHz	1.048 V	_____	1.073 V
Sine, 100 kHz	1.048 V	_____	1.073 V
Amplitude: 0.3536 Vrms			
DC, 1 mV			
Sine, 100 Hz	0.3411 V	_____	0.3660 V
Sine, 1 kHz	0.3411 V	_____	0.3660 V
Sine, 100 Hz	0.3411 V	_____	0.3660 V
Function Test			
Amplitude: 10 Vpp			
Square, 99.9 Hz	3.661V	_____	3.735V
Triangle, 99.9 Hz	3.643V	_____	3.754V
Pos Ramp, 99.9 Hz	3.643V	_____	3.754V
Neg Ramp, 99.9 Hz	3.643V	_____	3.754V
Square, 1 kHz	3.661V	_____	3.735V

Triangle, 2 kHz	3.643V	_____	3.754V
Pos Ramp, 500 Hz	3.643V	_____	3.754V
Neg Ramp, 500 Hz	3.643V	_____	3.754V
Square, 100 kHz	3.661V	_____	3.735V
Triangle, 10 kHz	3.513V	_____	3.883V
Pos Ramp, 10 kHz	3.328V	_____	3.996V
Neg Ramp, 10 kHz	3.328V	_____	3.996V

Amplitude: 3 Vpp

Square, 99.9 Hz	2.970 V	_____	3.030 V
Triangle, 99.9 Hz	2.955 V	_____	3.045 V
Pos Ramp, 99.9 Hz	2.955 V	_____	3.045 V
Neg Ramp, 99.9 Hz	2.955 V	_____	3.045 V
Square, 1 kHz	2.970 V	_____	3.030 V
Triangle, 2 kHz	2.955 V	_____	3.045 V
Pos Ramp, 500 Hz	2.955 V	_____	3.045 V
Neg Ramp, 500 Hz	2.955 V	_____	3.045 V
Square, 100 kHz	2.970 V	_____	3.030 V
Triangle, 10 kHz	2.850 V	_____	3.150 V
Pos Ramp, 10 kHz	2.700 V	_____	3.300 V
Neg Ramp, 10 kHz	2.700 V	_____	3.300 V

Amplitude: 1 Vpp
DC: 1 mV

Square, 99.9 Hz	0.970 V	_____	1.030 V
Triangle, 99.9 Hz	0.960 V	_____	1.040 V
Pos Ramp, 99.9 Hz	0.960 V	_____	1.040 V
Neg Ramp, 99.9 Hz	0.960 V	_____	1.040 V
Square, 1 kHz	0.970 V	_____	1.030 V
Triangle, 2 kHz	0.960 V	_____	1.040 V
Pos Ramp, 500 Hz	0.960 V	_____	1.040 V
Neg Ramp, 500 Hz	0.960 V	_____	1.040 V
Square, 100 kHz	0.970 V	_____	1.030 V
Triangle, 10 kHz	0.940 V	_____	1.060 V
Pos Ramp, 10 kHz	0.890 V	_____	1.110 V
Neg Ramp, 10 kHz	0.890 V	_____	1.110 V

High Voltage (Option 002) Sinewave Test

Amplitude: 14.14 Vrms

Sine, 2 kHz	13.86 V	_____	14.42 V
-------------	---------	-------	---------

High Voltage (Option 002) Function Test

Amplitude: 40 Vpp

Square, 2 kHz	3.466V	_____	3.607V
Triangle, 2 kHz	3.466V	_____	3.607V
Pos Ramp, 2 kHz	3.466V	_____	3.607V
Neg Ramp, 2 kHz	3.466V	_____	3.607V

Amplitude Flatness

Sine, 3 Vpp, 1 kHz
(Reference) _____ = Y

Allowable tolerance
(± 6.6%) _____
(0.934Y) _____ (1.066Y)

- 2.001 MHz _____
- 4.001 MHz _____
- 6.001 MHz _____
- 8.001 MHz _____
- 10.001 MHz _____
- 12.001 MHz _____
- 14.001 MHz _____
- 16.001 MHz _____
- 18.001 MHz _____
- 20.001 MHz _____

Sine, 10 Vpp, 1 kHz
(Reference) _____ = Y

Allowable tolerance
(± 6.3%) _____
(0.937Y) _____ (1.063Y)

- 2.001 MHz _____
- 4.001 MHz _____
- 6.001 MHz _____
- 8.001 MHz _____
- 10.001 MHz _____
- 12.001 MHz _____
- 14.001 MHz _____
- 16.001 MHz _____
- 18.001 MHz _____
- 20.001 MHz _____

Square, 10 Vpp, _____ (check one) _____
Pass Fail

High Voltage (Option 002) Flatness

Sine, 40 Vpp, _____ (check one) _____
Pass Fail

DC Offset Accuracy (DC Only)

Entry	Minimum	Maximum
5 V	+4.980 V	+5.020 V
-5 V	-4.980 V	-5.020 V
-1.499 V	-1.49300 V	-1.50499 V
1.499 V	+1.49300 V	+1.50499 V
499.9 mV	+0.49790 V	+0.50190 V
-499.9 mV	-0.49790 V	-0.50190 V
-149.9 mV	-0.14930 V	-0.15050 V
149.9 mV	+0.14930 V	+0.15050 V
49.99 mV	+0.04979 V	+0.05019 V
-49.99 mV	-0.04979 V	-0.05019 V
-14.99 mV	-0.01493 V	-0.01505 V
14.99 mV	+0.01493 V	+0.01505 V
4.999 mV	+0.004979 V	+0.005019 V
-4.999 mV	-0.004979 V	-0.005019 V
-1.499 mV	-0.001479 V	-0.001519 V
1.499 mV	+0.001479 V	+0.001519 V

High Voltage Output Option 002

20 V	+19.775 V	+20.225 V
-20 V	-19.775 V	-20.225 V

DC Offset Accuracy with AC Functions

Sine 20.999 999 999 MHz	Minimum	Maximum
4.5 V	+4.350 V	+4.650 V
-4.5 V	-4.350 V	-4.650 V

Sine 999.9 kHz

-4.5 V	-4.440 V	-4.560 V
4.5 V	+4.440 V	+4.560 V

Square 999.9 kHz

4.5 V	+4.440 V	+4.560 V
-4.5 V	-4.440 V	-4.560 V

Square 9.9999 MHz

-4.5 V	-4.350 V	-4.650 V
--------	----------	----------

Triangle 9.9 kHz

- 4.5 V

- 4.440 V _____ - 4.560 V

Ramp 9.9 kHz

- 4.5 V

- 4.380 V _____ - 4.620 V

Triangle Linearity

x Values	Positive Slope Measurement	x times y	Calculated Best Fit Straight Line	Tolerances	
				Minimum	Maximum
$x_1 = 1$	(10%) y_1 _____	_____	(y_1) _____	_____	_____
$x_2 = 2$	(20%) y_2 _____	_____	(y_2) _____	_____	_____
$x_3 = 3$	(30%) y_3 _____	_____	(y_3) _____	_____	_____
$x_4 = 4$	(40%) y_4 _____	_____	(y_4) _____	_____	_____
$x_5 = 5$	(50%) y_5 _____	_____	(y_5) _____	_____	_____
$x_6 = 6$	(60%) y_6 _____	_____	(y_6) _____	_____	_____
$x_7 = 7$	(70%) y_7 _____	_____	(y_7) _____	_____	_____
$x_8 = 8$	(80%) y_8 _____	_____	(y_8) _____	_____	_____
$x_9 = 9$	(90%) y_9 _____	_____	(y_9) _____	_____	_____
$\Sigma x = 45$	Σy _____	Σxy _____			
$(\Sigma x)^2 = 2025$	$\Sigma x \Sigma y$ _____				
$\Sigma x^2 = 285$					

x Values	Negative Slope Measurement	x times y	Calculated Best Fit Straight Line	Tolerances	
				Minimum	Maximum
$x_9 = 9$	(90%) y_9 _____	_____	(y_9) _____	_____	_____
$x_8 = 8$	(80%) y_8 _____	_____	(y_8) _____	_____	_____
$x_7 = 7$	(70%) y_7 _____	_____	(y_7) _____	_____	_____
$x_6 = 6$	(60%) y_6 _____	_____	(y_6) _____	_____	_____
$x_5 = 5$	(50%) y_5 _____	_____	(y_5) _____	_____	_____
$x_4 = 4$	(40%) y_4 _____	_____	(y_4) _____	_____	_____
$x_3 = 3$	(30%) y_3 _____	_____	(y_3) _____	_____	_____
$x_2 = 2$	(20%) y_2 _____	_____	(y_2) _____	_____	_____
$x_1 = 1$	(10%) y_1 _____	_____	(y_1) _____	_____	_____
$\Sigma z = 45$	Σy _____	Σxy _____			
$(\Sigma x)^2 = 2025$	$\Sigma x \Sigma y$ _____				
$\Sigma x^2 = 285$					

x Drive Linearity

x Values	Positive Slope Measurement	x times y	Calculated Best Fit Straight Line	Tolerances	
				Minimum	Maximum
$x_1 = 1$	(10%) y_1 _____	_____	(y_1) _____	_____	_____
$x_2 = 2$	(20%) y_2 _____	_____	(y_2) _____	_____	_____
$x_3 = 3$	(30%) y_3 _____	_____	(y_3) _____	_____	_____
$x_4 = 4$	(40%) y_4 _____	_____	(y_4) _____	_____	_____
$x_5 = 5$	(50%) y_5 _____	_____	(y_5) _____	_____	_____
$x_6 = 6$	(60%) y_6 _____	_____	(y_6) _____	_____	_____
$x_7 = 7$	(70%) y_7 _____	_____	(y_7) _____	_____	_____
$x_8 = 8$	(80%) y_8 _____	_____	(y_8) _____	_____	_____
$x_9 = 9$	(90%) y_9 _____	_____	(y_9) _____	_____	_____
$\Sigma z = 45$	Σy _____	Σxy _____			
$(\Sigma x)^2 = 2025$	$\Sigma x \Sigma y$ _____				
$\Sigma x^2 = 285$					

Ramp Period Variation

Negative Slope Ramp, 100 Hz	_____ < $\pm 100 \mu s$
Positive Slope Ramp, 100 Hz	_____ < $\pm 100 \mu s$
Positive Slope Ramp, 99.9 Hz	_____ < $\pm 100 \mu s$

Specifications

FREQUENCY

Range:

Sine: 1 μ Hz to 20,999 999 999 MHz

Square: 1 μ Hz to 10,999 999 999 MHz

Triangle/Ramps: 1 μ Hz to 10,999 999 999 kHz

Resolution:

1 μ Hz, <100 kHz

1 mHz \geq 100 kHz (1 μ Hz available, not displayed)

Accuracy:

$\pm 5 \times 10^{-6}$ of selected value, 20°C to 30°C, at time of calibration (Standard Instrument)

Stability:

$\pm 5 \times 10^{-6}$ /year, 20°C to 30°C, standard (See also option 001, high stability frequency reference)

Warm-up Time:

20 minutes to within specified accuracy.

MAIN SIGNAL OUTPUT

(all waveforms)

Impedance:

50 $\Omega \pm 1\Omega$, 0-10 kHz

Return Loss:

> 20 dB, 10 kHz to 20 MHz, except > 10 dB for > 3 V, 5 MHz to 20 MHz

Connector:

BNC; switchable to front or rear panel, non-switchable with option 002 except by internal cable change.

Floating:

Output may be floated up to 42V peak (AC + DC)

AMPLITUDE (all waveforms)

Resolution:

0.03% of full range or 0.01 dB (4 digits).

Range:

1 mV to 10 Vp-p in 8 amplitude ranges, 1-3-10 sequence. Ranges are 1 mV-2.999 mV, 3 mV-9.999 mV, 10 mV-29.99 mV, 30 mV-99.99 mV, .1 V-.2999 V, .3 V-.9999 V, 1V-2.999 V, 3 V-10V, (without DC offset).

Function	peak to peak	rms	dBm(50 Ω)
Sine	min.	1.000 mV	0.354 mV
	max.	10.00 V	3.536 V
Square	min.	1.000 mV	0.500 mV
	max.	10.00 V	5.000 V
Triangle/Ramps	min.	1.000 mV	0.289 mV
	max.	10.00 V	2.887 V
			dBm(50 Ω)
			-56.02
			+23.98
			-53.01
			+26.99
			-57.78
			+22.22

Accuracy: (with 0 Vdc offset)

Sine:

	.001 Hz	100 kHz	10 MHz	20 MHz
+23.98 dBm	$\pm .1$ dB		$\pm .4$ dB	
+13.52 dBm				$\pm .6$ dB
-16.02 dBm	$\pm .2$ dB		$\pm .6$ dB	
-56.02 dBm				$\pm .9$ dB

Square Wave:

	.001 Hz	100 kHz	10 MHz
10 Vp-p	$\pm 1.0\%$		$\pm 11.1\%$
3 Vp-p			
1 mVp-p	$\pm 2.2\%$		$\pm 13.6\%$

Triangle:

	.001 Hz	2 kHz	10 kHz
10 Vp-p	$\pm 1.5\%$		$\pm 5.0\%$
3 Vp-p			
1 mVp-p	$\pm 2.7\%$		$\pm 6.2\%$

Ramps:

	.001 Hz	500 kHz	10 kHz
10 Vp-p	$\pm 1.5\%$		$\pm 10\%$
3 Vp-p			
1 mVp-p	$\pm 2.7\%$		$\pm 11.2\%$

With DC offset, increase all sinewave tolerances by .2 dB and all function tolerances by 2%.

SINEWAVE SPECTRAL PURITY

Phase Noise:

- 60 dBc for a 30 kHz band centered on a 20 MHz carrier (excluding ± 1 Hz about the carrier) with option 001 installed.

Spurious:

All non-harmonically related output signals will be more than 70 dB below the carrier (- 60 dBc with DC offset), or less than - 90 dBm, whichever is greater.

WAVEFORM CHARACTERISTICS

Sinewave Harmonic Distortion:

Harmonically related signals will be less than the following levels relative to the fundamental:

Frequency Range	Harmonic Level
.1 Hz to 50 kHz	- 65 dBc
50 kHz to 200 kHz	- 60 dBc
200 kHz to 2 MHz	- 40dBc
2 MHz to 15 MHz	- 30 dBc
15 MHz to 20 MHz	- 25 dBc

Squarewave Characteristics:

Rise/fall time: ≤ 20 ns 10% to 90%, at full output.

Overshoot: $\leq 5\%$ of peak to peak amplitude, at full output at 1MHz.

Settling time: <1 μ s to settle to within .05% of final value, tested at full output with no load, 10 Hz to 500 kHz.

Symmetry: $\leq .02\%$ of period + 3 ns.

Triangle/Ramp Characteristics:

Triangle/ramp linearity (10% to 90%, 10 kHz): $\pm .05\%$ of full p-p output for each range.

Ramp retrace time: ≤ 3 μ s, 90% to 10%.

Period variation for alternate ramp cycles: $\leq 1\%$ of period.

DC OFFSET

Range:

DC only (no AC signal): 0 to ± 5.0 V/50 Ω

DC + AC: Maximum DC offset ± 4.5 V on highest range; decreasing to ± 4.5 mV on lowest range.

Resolution: 4 digits

Accuracy:

DC only: $\pm .02$ mV to ± 20 mV, depends on offset chosen.

DC + AC, to 1MHz: $\pm .06$ mV to ± 60 mV, depends on AC output level, $\pm .2$ mV to ± 120 mV for ramps to 10 kHz.

DC + AC, 1 MHz to 20 MHz: ± 15 mV to ± 150 mV, depends on AC output level.

PHASE OFFSET**Range:**

$\pm 719.9^\circ$ with respect to arbitrary starting phase, or assigned zero phase.

Resolution: 0.1°

Increment Accuracy: $\pm 0.2^\circ$

Stability: ± 1.0 degree of phase/ $^\circ\text{C}$

SINEWAVE AMPLITUDE MODULATION

Modulation Depth (at full output for each range):

0–100%

Modulation Frequency Range:

DC to 400 kHz (0–21 MHz carrier frequency)

Envelope Distortion:

–30 dB to 80% modulation at 1 kHz, 0 VDC offset

Sensitivity:

± 5 V peak for 100% modulation

Input Impedance: 10 k Ω

Connector: Rear panel BNC

PHASE MODULATION

Sine Function Range:

$\pm 850^\circ$, ± 5 V input

Sine Function-Linearity:

$\pm 0.5\%$, best fit straight line

Squarewave Range: $\pm 425^\circ$

Triangle Range: $\pm 42.5^\circ$

Positive and Negative Ramps:

$\pm 85^\circ$

Modulation Frequency Range:

DC – 5 kHz

Input Impedance: > 40 k Ω

Connector: Rear panel BNC

FREQUENCY SWEEP

Sweep Time:

Linear: 0.01s to 1000s

Logarithmic: 1s to

1000s single, 0.1s to 1000s continuous

Maximum Sweep Width:

Full frequency range of the main signal output for the waveform in use except minimum log start frequency is 1 Hz.

Minimum Sweep Width:

Function	Minimum sweep width	
	Sweep time .01 sec.	Sweep time 99.9 sec.
Sine:	.1 mHz	999.9 mHz
Square:	.05 mHz	499.5 mHz
Triangle:	.005 mHz	49.95 mHz
Ramps:	.01 mHz	99.99 mHz

Minimum log sweep width is 1 decade.

Phase Continuity:

Sweep is phase continuous over the full frequency range of the main output.

Discrete Sweep:

Number of segments: 100 maximum (Start and stop frequencies settable for each segment)

Time/segment: 0.01s to 1000s, 0.01s resolution

MODULATION SOURCE:

Frequency Range: Sine 0.1Hz–10 kHz,

Square 0.1Hz–2 kHz

Frequency Resolution: 2 digits

Frequency Accuracy: Typically 0.1% (Sinewave)

Amplitude Range: 0.1 Vp-p to 12 Vp-p

Amplitude Resolution: 0.1V

Amplitude Accuracy: Typically ± 200 mV

Impedance: Designed to drive ≥ 10 k Ω loads

Sinewave Purity: Typically better than –34 dBc

Standard Waveforms: Sine, Square

Arbitrary Waveforms: Vertical resolution 256 points, horizontal resolution 4096 points, 300,000 samples/sec, 10 kHz maximum.

Output Location: Rear Panel BNC

AUXILIARY OUTPUTS

Auxiliary Frequency Output:

Frequency Range: 21 MHz to 60.999 999 999 MHz, underrange coverage to 19.000 000 001 MHz, frequency selection from front panel.

Amplitude: 0 dBm; output impedance: 50 Ω

Connector: Rear panel BNC

Sync Output:

Square wave with $V_{\text{high}} \geq 1.2$ V, $V_{\text{low}} \leq 0.2$ V into 50 Ω . Frequency range is the same as the main signal output for front panel sync and DC–60 MHz for rear panel sync.

Output impedance: 50 Ω

Connector: BNC front and rear panels.

X-Axis Drive:

(0–100s sweeps only)

0 to +10 Vdc linear ramp proportional to sweep frequency; linearity, 10–90%, $\pm .1\%$ of final value (applies for sweep widths which are integer multiples of the minimum sweep width).

Connector: Rear panel BNC.

Sweep Marker Output:

High to low TTL compatible voltage transition at keyboard selected marker frequency. (Linear sweep only.)

Connector: Rear panel BNC.

Z-Axis Blank Output:

TTL compatible voltage levels capable of sinking current from a positive source. Current 200 mA, voltage 45V, power dissipation 1 watt maximum.

1 MHz Reference Output:

0 dBm output for phase-locking additional instruments to the HP 3325B.

Connector: Rear panel BNC.

10 MHz Oven Output:

0 dBm internal high stability frequency reference output for phase-locking HP 3325B or other instruments (option 001 only).

Connector: Rear panel BNC.

AUXILIARY INPUTS**Reference Input:**

For phase-locking HP 3325B to an external frequency reference. Signal from 0 dBm to +20 dBm into 50 Ω . Reference signal must be a subharmonic of 10 MHz from 1 MHz to 10 MHz.

Connector: Rear panel BNC. With option 001 this input may be jumpered to the 10 MHz reference output.

Amplitude Modulation Input:

See modulation specifications.

Phase Modulation Input:

See modulation specifications.

REMOTE CONTROL**Frequency Switching Time (to within 1 Hz exclusive of programming time):**

≤ 10 ms for 100 kHz step; ≤ 25 msec for 1 MHz step; ≤ 70 msec for 20 MHz step.

Phase Switching Time (to within 90° of phase lock exclusive of programming time):

≤ 15 msec.

Amplitude Switching Time (to within amplitude specifications, exclusive of programming time):

< 30 ms.

HP-IB Interface Functions:

SH1, AHL, T6, L3, SRL, RL1, PP0, DC1, DTL, C0, E1

RS-232 Interface:

Subset of ANSI/EIA-232D-1986, CCITT V.24

Type: DTE, 25 pin female "D" connector

Baud Rate: 300-4800

OPTION 001 HIGH STABILITY FREQUENCY REFERENCE**Aging Rate:**

$\pm 5 \times 10^{-8}$ /week, after 72 hours continuous operation; $\pm 1 \times 10^{-7}$ mo., after 15 days continuous operation.

Warm-up time:

Reference will be within $\pm 1 \times 10^{-7}$ of final value 15 minutes after turn-on at 25°C for an off time of less than 24 hours.

OPTION 002 HIGH VOLTAGE OUTPUT**Frequency Range:** 1 μ Hz to 1 MHz**Amplitude:**

Range: 4.00 mV to 40.00 Vp-p in 8 ranges, 4-12-40 sequence, into 500 Ω $<$ 500 pF load. Ranges are four times the standard instrument ranges, without DC offset.

Accuracy: $\pm 2\%$ of full output for each range at 2 kHz.

Flatness: $\pm 10\%$ relative to programmed amplitude.

Sinewave Distortion:

Harmonically related signals will be less than the following levels (relative to the fundamental full output into 500 Ω , load):

10 Hz-50 kHz: -65 dB

50 kHz-200 kHz: -60 dB

200 kHz-1 MHz: -40 dB

Square Wave Rise/Fall Time:

± 125 ns, 10% to 90% at full output, with 500 Ω , 500 pF load.

Square Wave Overshoot:

$\pm 10\%$ of peak to peak amplitude with 500 Ω , 500 pF load.

Output Impedance:

$< 2\Omega$ at DC, $< 10\Omega$ at 1 MHz

DC Offset:

Range: 4 times the specified range of the standard instrument.

Accuracy: $\pm 1\%$ of full output for each range + 25 mV).

Maximum Output Current:

± 20 mA peak

GENERAL**Operating Environment:**

Temperature: 0°C to 55°C

Relative Humidity: 95%, 0°C to 40°C

Altitude: $\leq 15,000$ ft.

Power:

100/120/220/240 V, +5%, -10%; 48 to 66 Hz; 90 VA, 120 VA with all options

Weight:

9 kg (20 lbs) net; 14.5 kg (32 lbs) shipping

Dimensions:

133.4 mm high \times 425.5 mm wide \times 498.5 mm deep (5 $\frac{1}{4}$ " H \times 16 $\frac{3}{4}$ " W \times 19 $\frac{5}{8}$ " D)

Index

A

- Amplitude
 - Accuracy test 4-38
 - Flatness check 4-15
 - Modulation envelope distortion test 4-28
- Attenuator check 4-16

C

- Circuit breaker 4-3

D

- DC offset accuracy
 - AC functions test 4-46
 - DC only test 4-45

F

- Frequency accuracy test 4-16, 4-32

H

- Harmonic distortion test 4-17, 4-23
- High voltage output
 - Amplitude accuracy test 4-41, 4-44
 - DC offset accuracy test 4-45
 - Harmonic distortion check 4-18
 - Harmonic distortion test 4-24
 - Sine wave verification 4-13
- HP-IB system interface connections 4-8

I

- Initial inspection 4-2
- Installation 4-6
- Instrument cooling 4-6

L

- Line voltage selection 4-3

O

- Operating environment 4-6
- Operational verification
 - Amplitude flatness 4-15
 - Close-in spurious signal 4-19
 - Frequency accuracy 4-16
 - Harmonic distortion 4-17
 - Output level and attenuator 4-16
 - Required test equipment 4-11
 - Self test 4-12
 - Sine wave 4-12
 - Square wave 4-13
 - Sync output 4-15
 - Triangle and ramp 4-14
- Output level check 4-16
- Over-voltage circuit breaker 4-3

P

- Performance tests
 - Amplitude accuracy 4-38
 - Amplitude modulation envelope distortion 4-28
 - DC offset accuracy 4-45
 - DC offset accuracy with ac functions 4-46
 - Frequency accuracy 4-32
 - Harmonic distortion 4-23
 - Integrated phase noise 4-27
 - Phase increment accuracy 4-33
 - Phase modulation linearity 4-34
 - Ramp period variation 4-54
 - Ramp retrace time 4-30
 - Required test equipment 4-20
 - Spurious signal 4-25
 - Square wave rise time and aberrations 4-29
 - Square wave symmetry 4-31
 - Sync output 4-30
 - Triangle linearity 4-47
 - X drive linearity 4-50
- Phase
 - Increment accuracy test 4-33
 - Integrated phase noise test 4-27
 - Modulation linearity test 4-34
- Power
 - Cable grounding requirements 4-4
 - Requirements 4-2

R

- Ramp
 - Period variation test 4-54
 - Retrace time test 4-30
 - Verification 4-14
- Required test equipment
 - Operational verification 4-11
 - Performance tests 4-20

S

- Self test 4-12
- Sine wave verification 4-12
- Spurious signal test 4-19, 4-25
- Square wave
 - Rise time and aberrations test 4-29
 - Symmetry test 4-31
 - Verification 4-13
- Storage and shipment 4-10
- Sync output test 4-15, 4-30

T

- Triangle
 - Linearity test 4-47
 - Verification 4-14

X

- X drive linearity test 4-50

Hewlett-Packard Sales and Service Offices

To obtain Servicing information or to order replacement parts, contact the nearest Hewlett-Packard Sales and Service Office listed in HP Catalog, or contact the nearest regional office listed below:

In the United States

California

P.O. Box 4230
1421 South Manhattan Avenue
Fullerton 92631

Georgia

P.O. Box 105005
2000 South Park Place
Atlanta 30339

Illinois

5201 Tollview Drive
Rolling Meadows

New Jersey

W. 120 Century Road
Paramus 07652

In Canada

Hewlett-Packard (Canada) Ltd.
17500 South Service Road
Trans-Canada Highway
Kirkland, Quebec H9J 2M5

In France

Hewlett-Packard France
F-91947 Les Ulis Cedex
Orsay

In German Federal Republic

Hewlett-Packard GmbH
Vertriebszentrale Frankfurt
Berner Strasse 117
Postfach 560 140
D-6000 Frankfurt 56

In Great Britain

Hewlett-Packard Ltd.
King Street Lane
Winnersh, Wokingham
Berkshire RG11 5AR

In Other European Countries

Switzerland

Hewlett-Packard (Schweiz) AG
7, rue du Bois-du-Lan
Case Postale 365
CH-1217 Meyrin

In All Other Locations

Hewlett-Packard Inter-Americas
3155 Porter Drive
Palo Alto, California 94304